

Terasa Broj 1.	U.O Šarengrad VI. Arbeša Kamberi PC Mali Palit
K.Č.BR.	225/67
Zona	0.
Kvadratura	50m ²
Period	Sezonsko

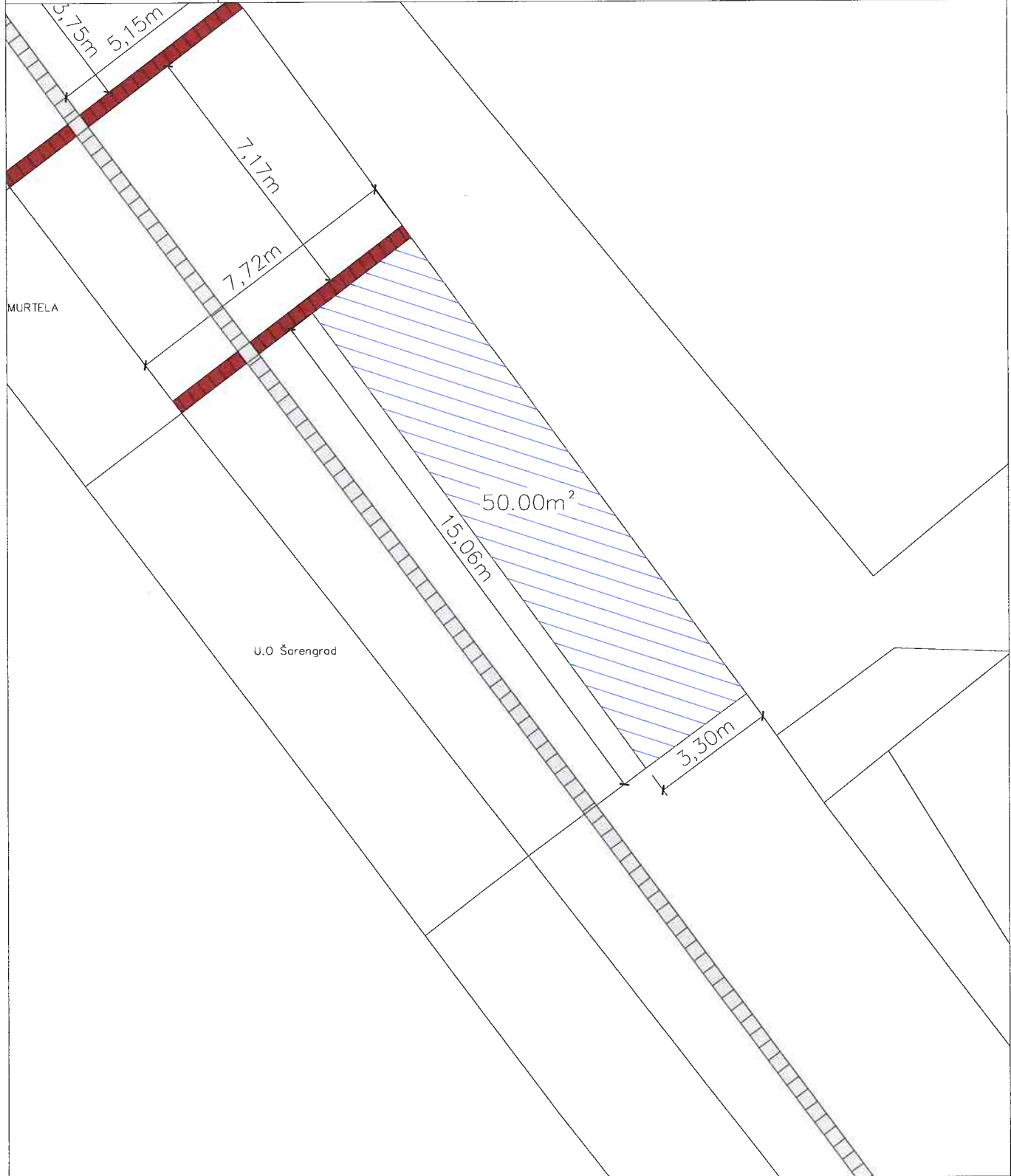

Terasa Broj 2.	U.O. Čipe vl. Darko Markovinović PC Mali Palit
K.Č.BR.	225/67
Zona	0.
Kvadratura	10,6 m ²
Period	Cjelogodišnje

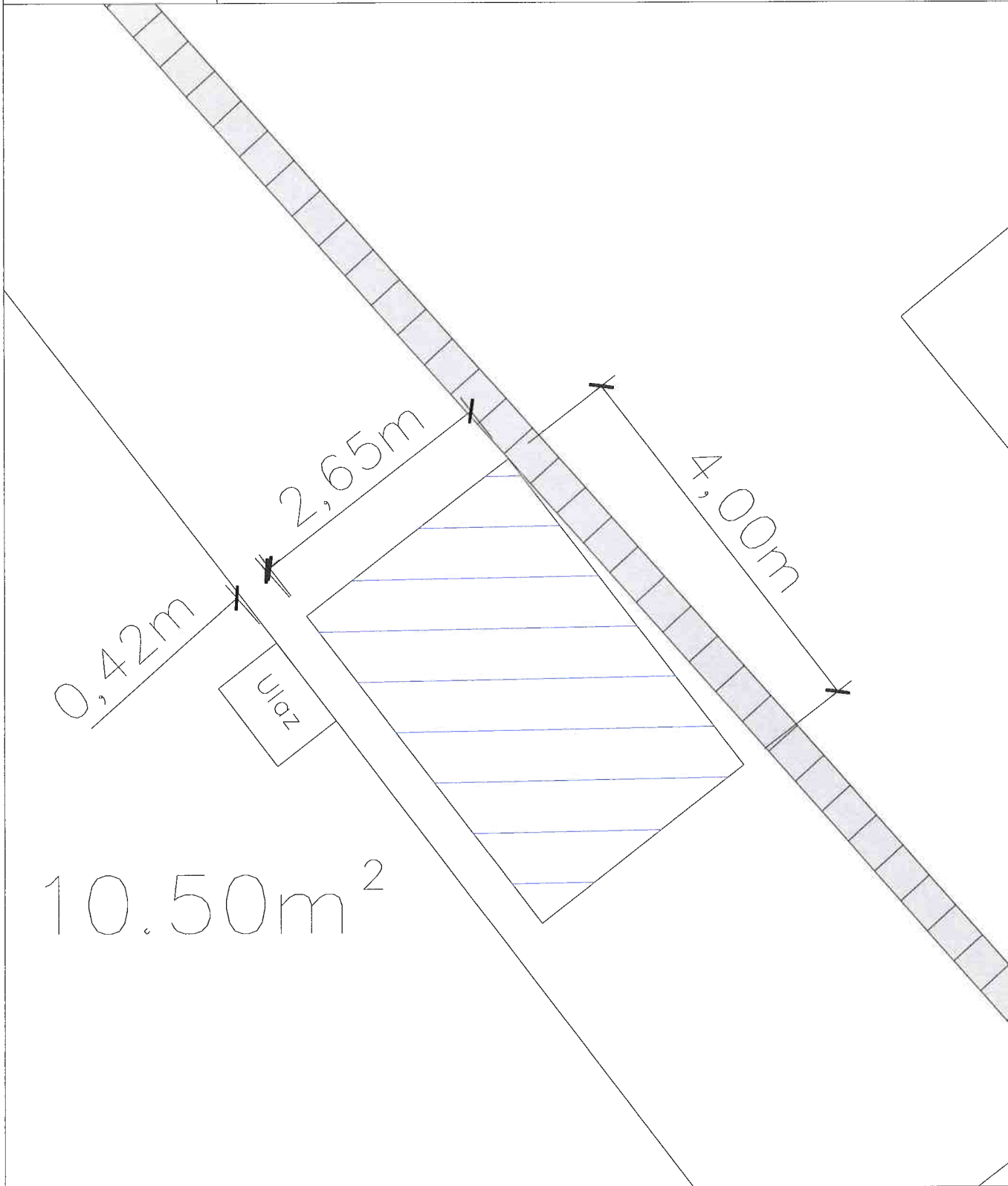

Terasa Broj 3.	Vanilla j.d.o.o. vl Hana Kolgjeraj PC Mali Palit
k.Č.BR.	225/67
Zona	0.
Kvadratura	49,0 m ²
Period	Cjelogodišnje

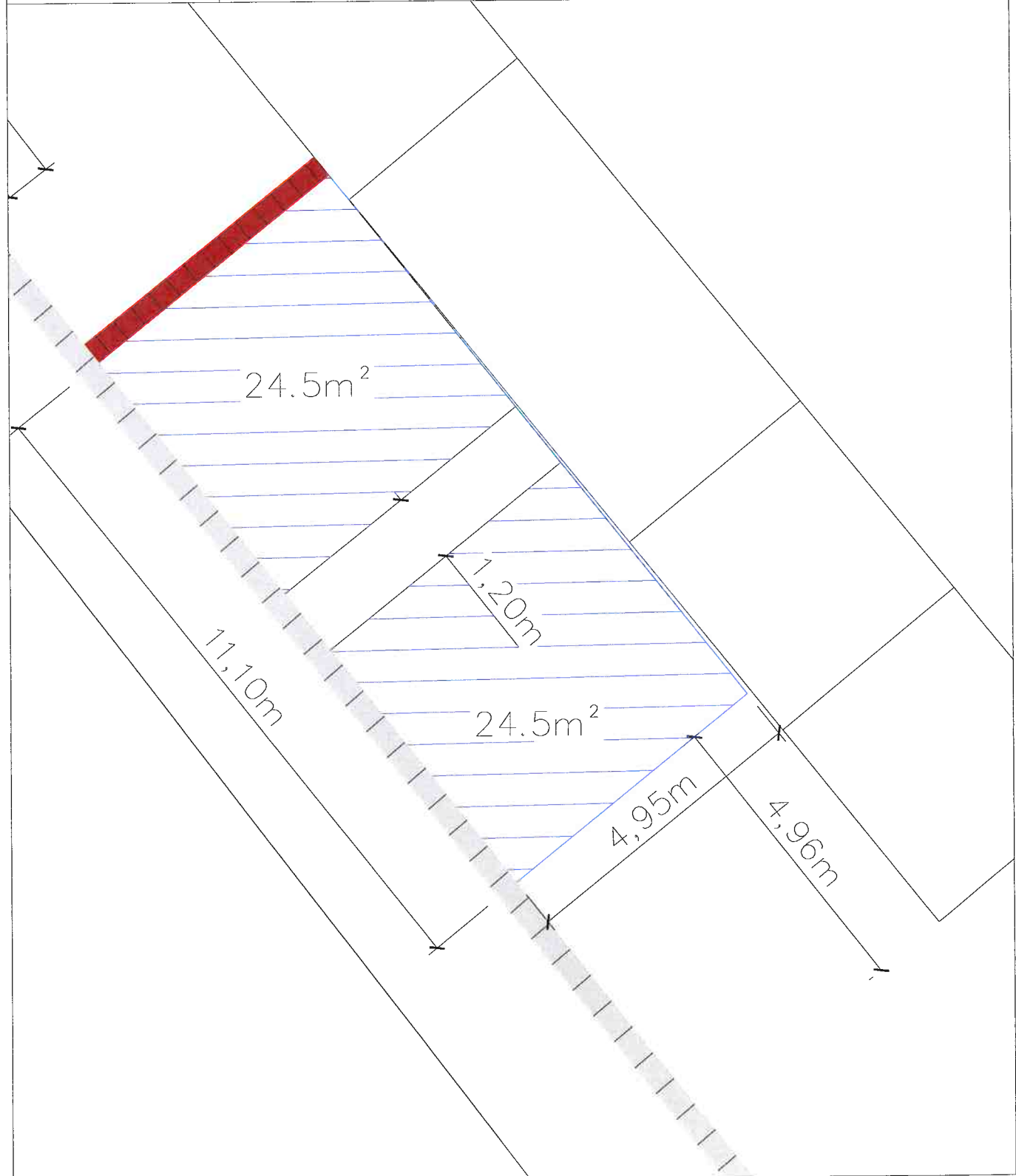

Terasa Broj 4.	z.u.o. "I&N" PC Mali Palit
K.Č.BR.	245/6
Zona	0.
Kvadratura	25,0 m ²
Period	Cjelogodišnje

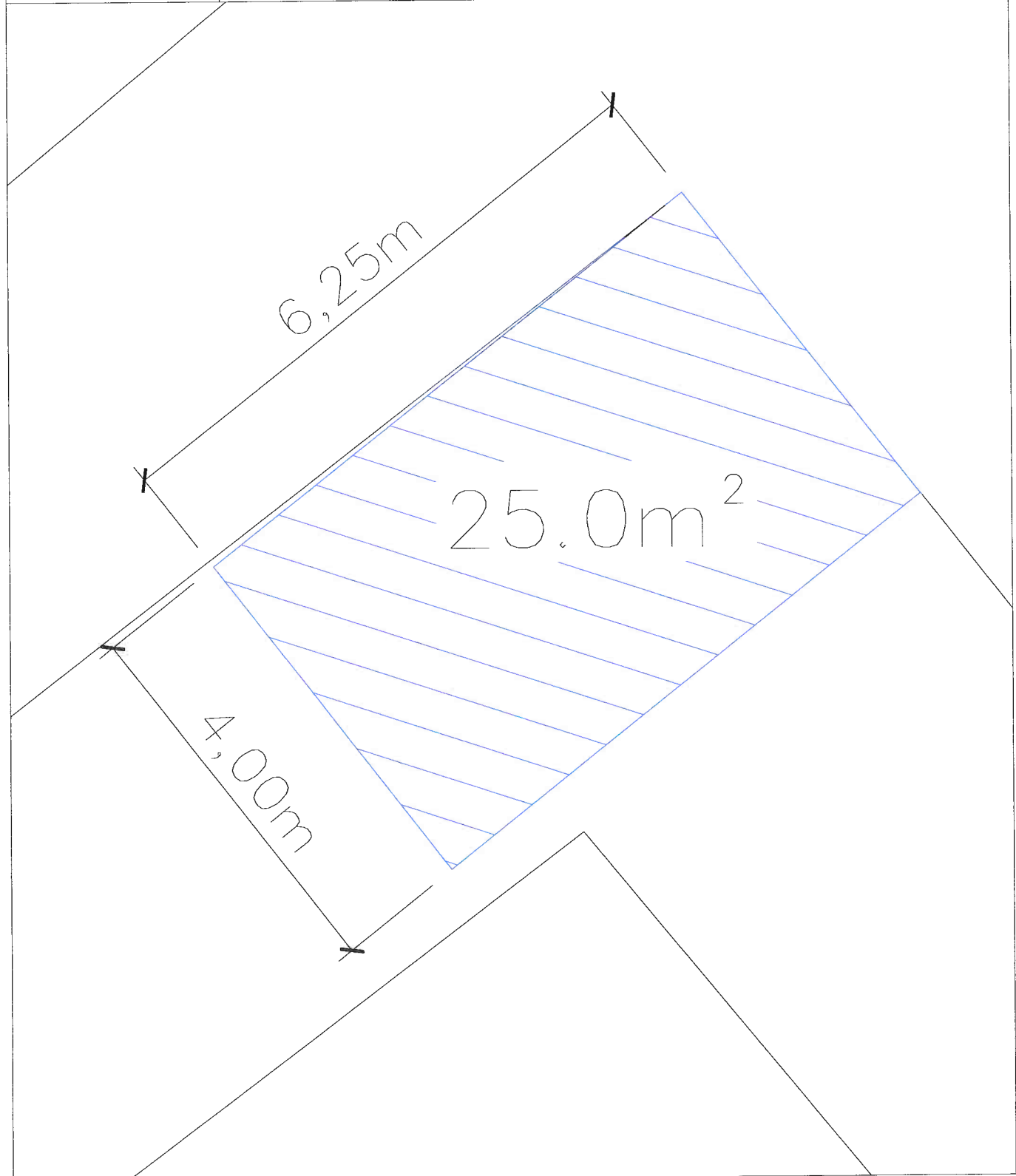

Terasa
Broj 5.

U.O L&K VI. Kristina Šimičić
PC Mali Palit

K.Č.BR.	225/67
Zona	0.
Kvadratura	32,0m ²
Period	Cjelogodišnje

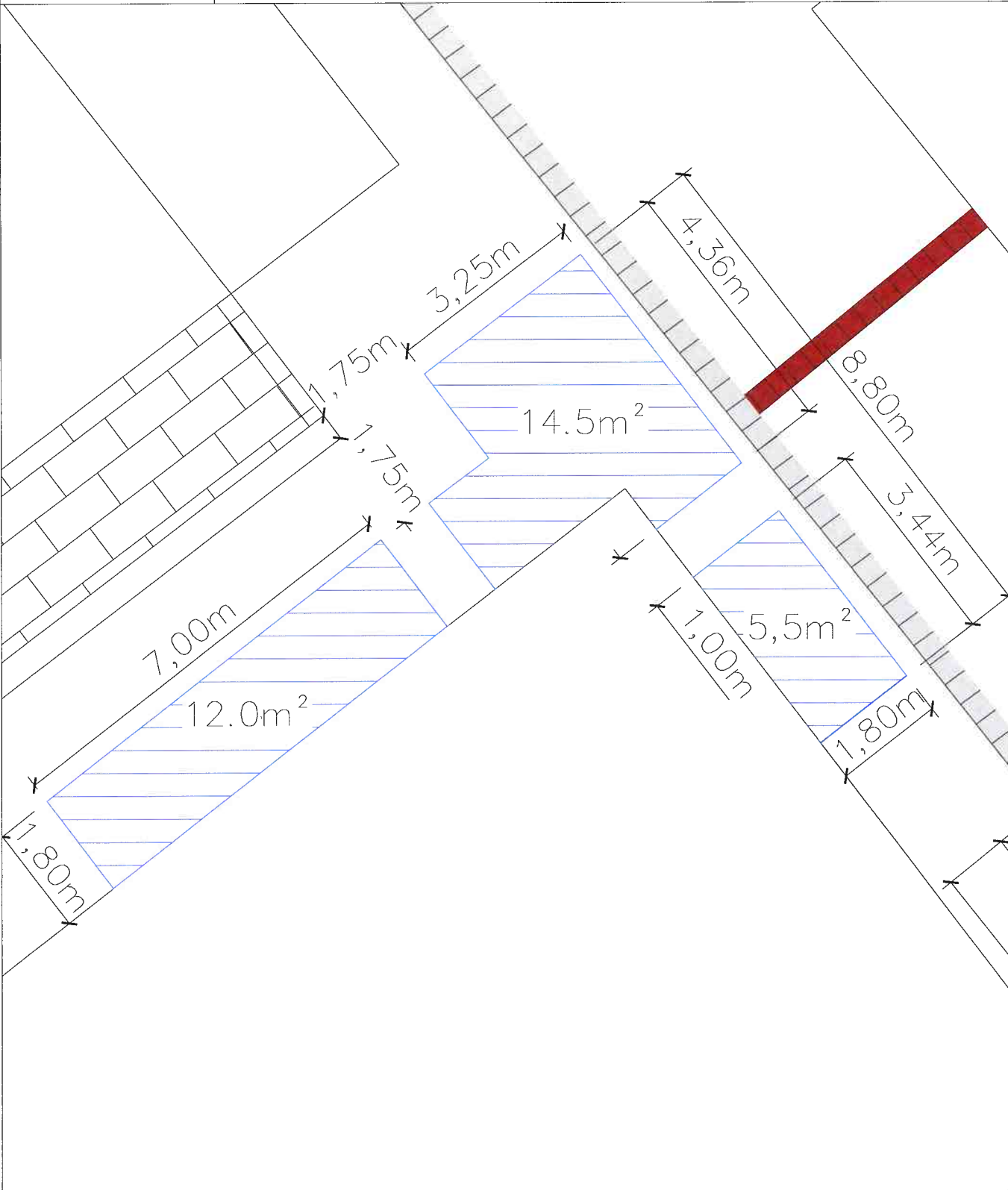

Terasa
Broj 6.

U.O Rab VI. Sala Demaili
Trg Municipium Arba

K.Č.BR. 2263/1

Zona 0.

Kvadratura 77,0m²

Period Sezonsko



Terasa Broj 7.	Z.U.O. Velora VI. Ivano Španjol, Karlo Španjol Trg Municipium Arba		
K.Č.BR.	2263/1		
Zona	0.		
Kvadratura	150,0m ² , šank-točionik 5m ²		
Period	Cjelogodišnje		
Antonio			
Antonio			

Terasa Broj 8.	j.d.o.o. Rab barovi vl. Josip Brna Obala Kralja Petra Krešimira, Trg Municipium Arba
K.Č.BR.	2263/1, 2263/52
Zona	0., 0.
Kvadratura	56,5m ² , 17,5m ²
Period	Cjelogodišnje

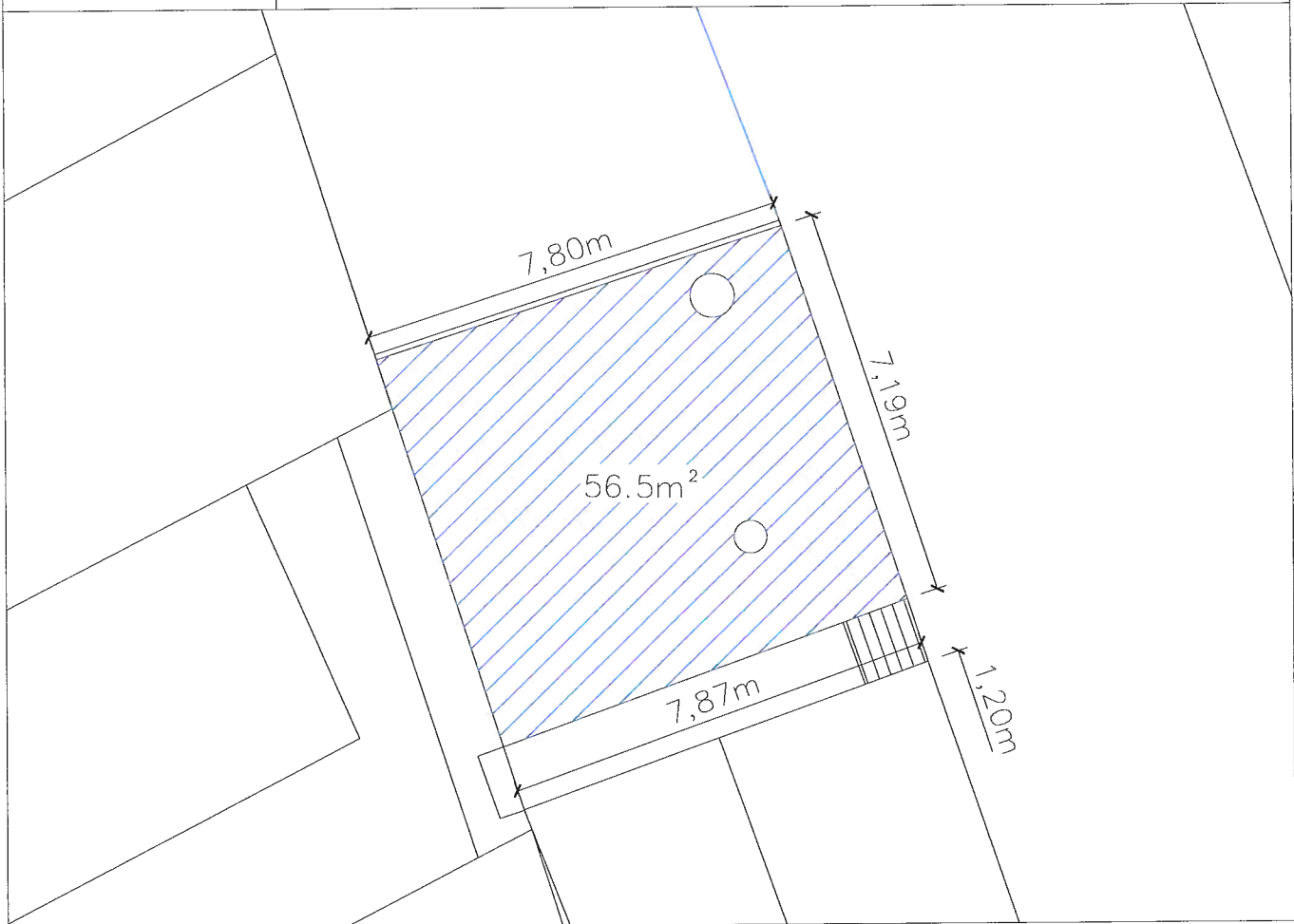

Terasa Broj 10.	U.O. San Antonio VI. Nenad Čule Trg Municipium Arba		
K.Č.BR.	2263/1		
Zona	0.		
Kvadratura	149,0m ² , šank-točionik 3,5m ²		
Period	Cjelogodišnje		
<p>The diagram illustrates the layout of the 'San Antonio' and 'Velora' areas. The 'San Antonio' area is shaded with blue diagonal lines and consists of a large rectangular area (126.0m²) and two smaller rectangular areas (11.0m² and 12.0m²). A small square area (3.5m²) is also shown within the large 'San Antonio' area. Dimensions are provided for various sections and setbacks. The 'Velora' area is shown to the right of the 'San Antonio' area. The diagram includes labels for 'Ulaz' (Entrance) and various dimensions in meters.</p>			

Terasa Broj 11.	U.O. Revelin VI. Ivan Palić Trg Municipium Arba
--------------------	--

K.Č.BR.	2263/1
---------	--------

Zona	0.
------	----

Kvadratura	147,0m ²
------------	---------------------

Period	Sezonsko
--------	----------

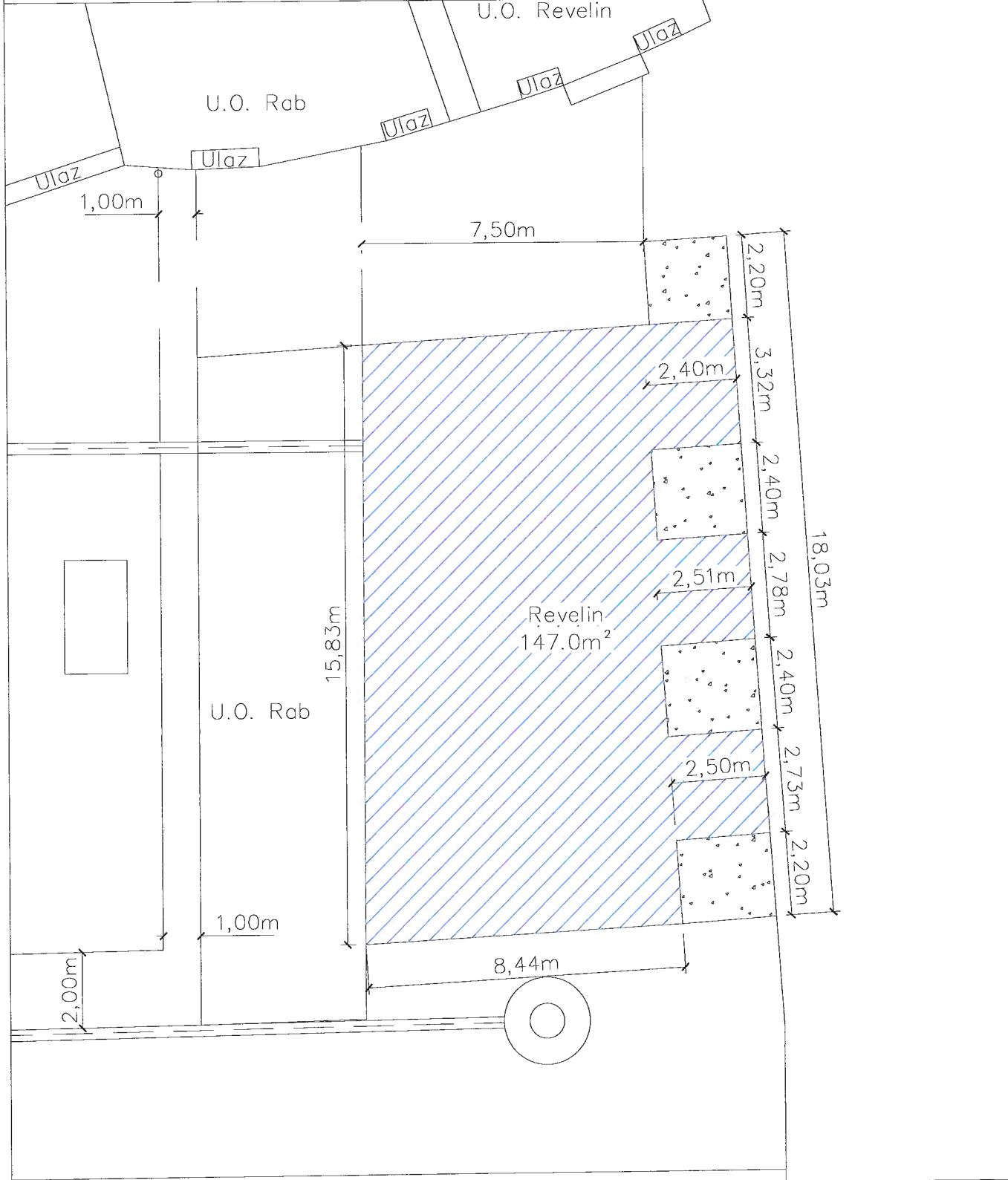

Terasa z.u.o. Caffe Bar "FELIX" vl. Ivica Badurina i Željko Dumičić
Broj 12. Trg sv. Kristofora

K.Č.BR.	121
Zona	0.
Kvadratura	104 m ²
Period	Sezonsko

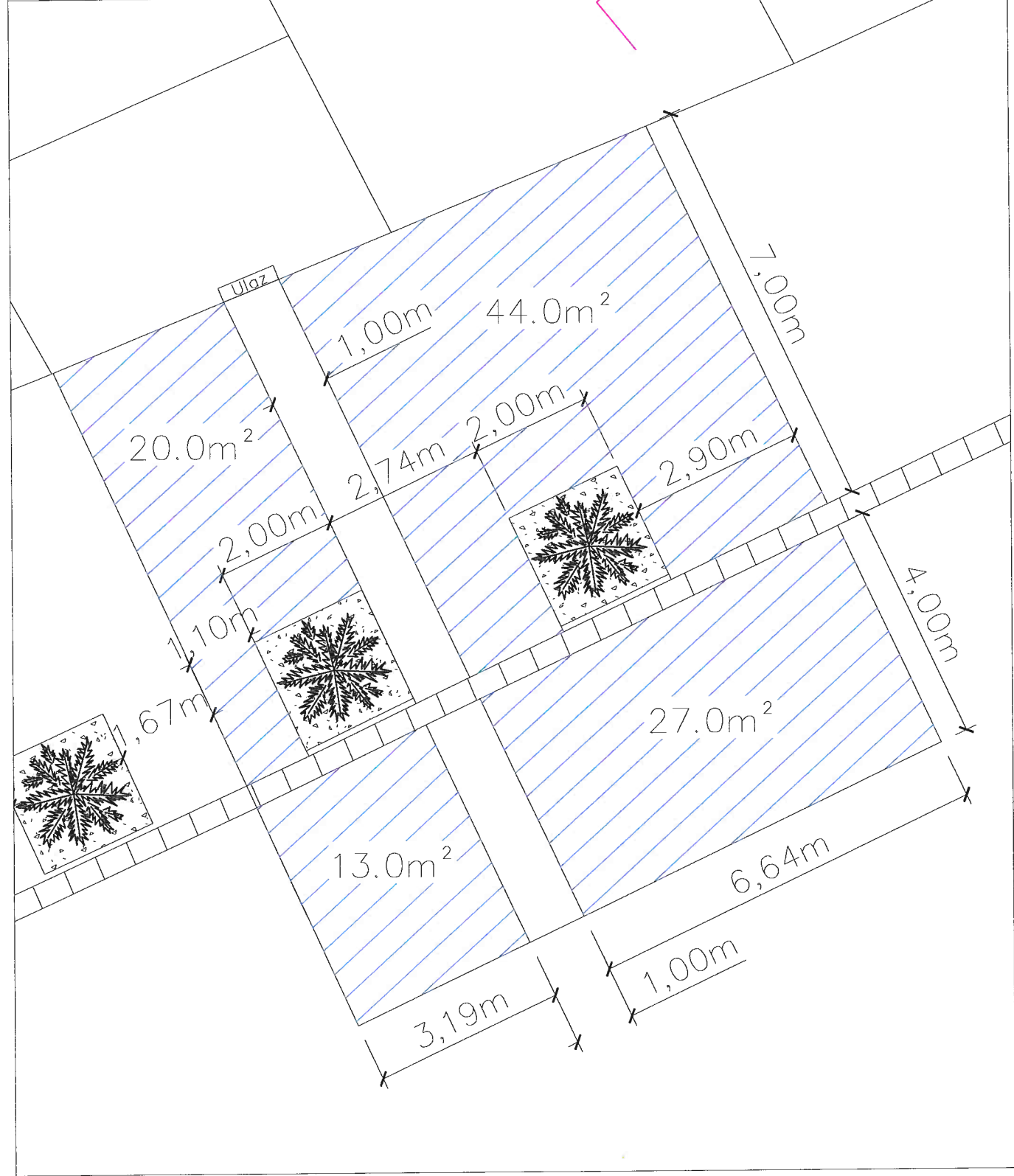

Terasa Broj 13.	PARK-Renić d.o.o. Trg sv. Kristofora
--------------------	---

K.Č.BR.	121
Zona	0.
Kvadratura	170 m ²
Period	Sezonsko

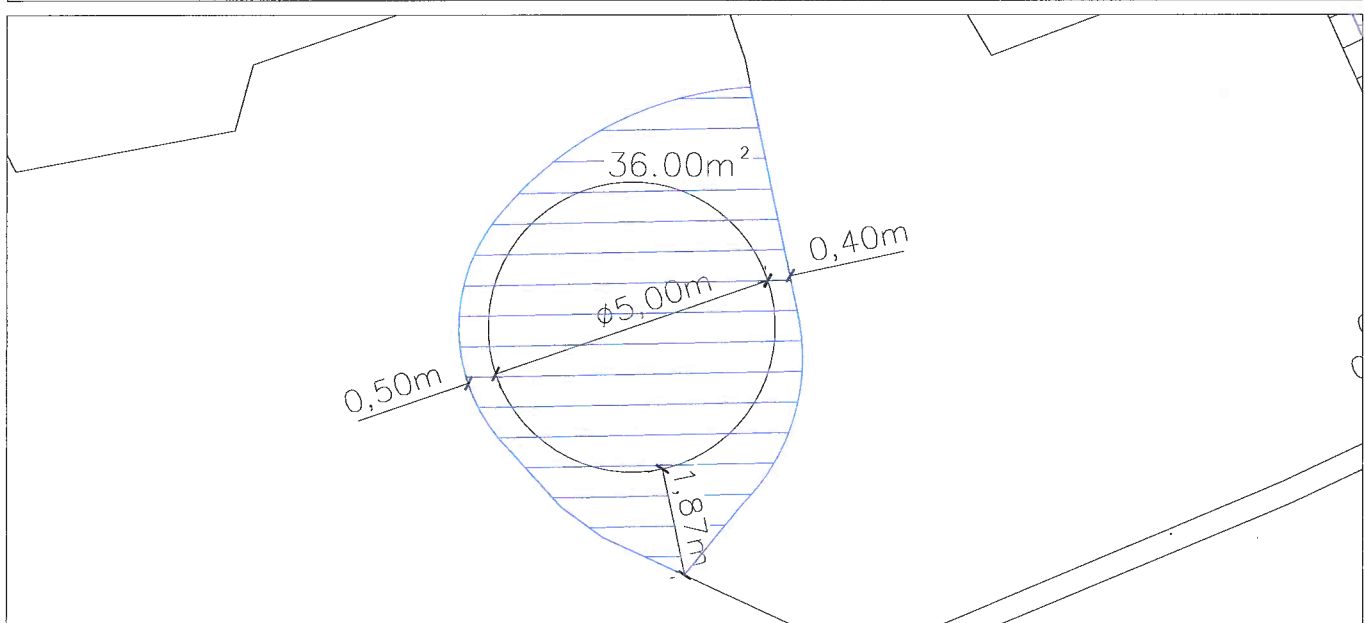
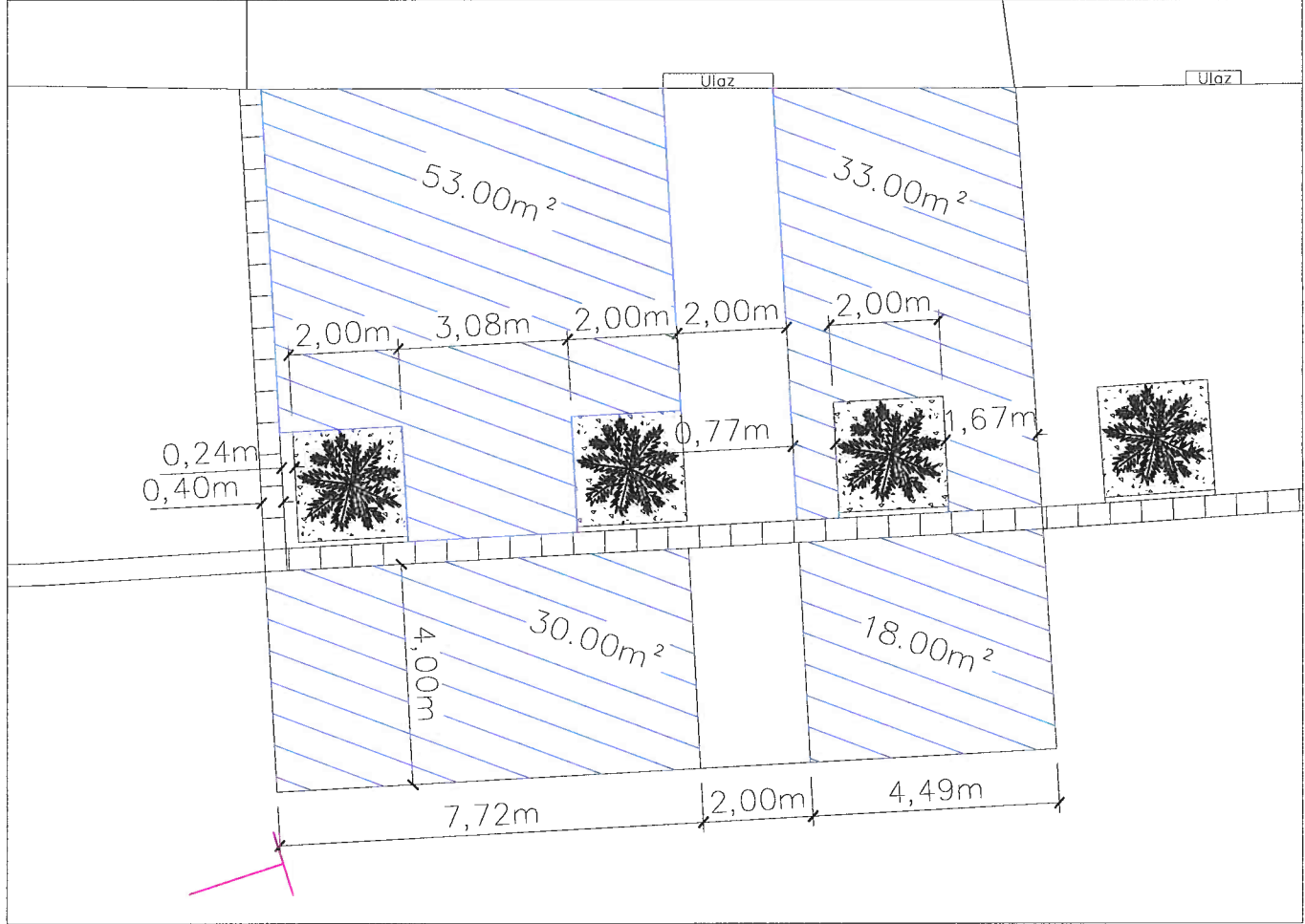

Terasa Broj 14.	U.O. Riva vl. Boris Brusić–Renaud Obala Kralja Petra Krešimira, Ulica Biskupa Draga
K.Č.BR.	2263/1, 2263/33
Zona	0., I.
Kvadratura	69m ² , 7,0m ²
Period	Sezonsko

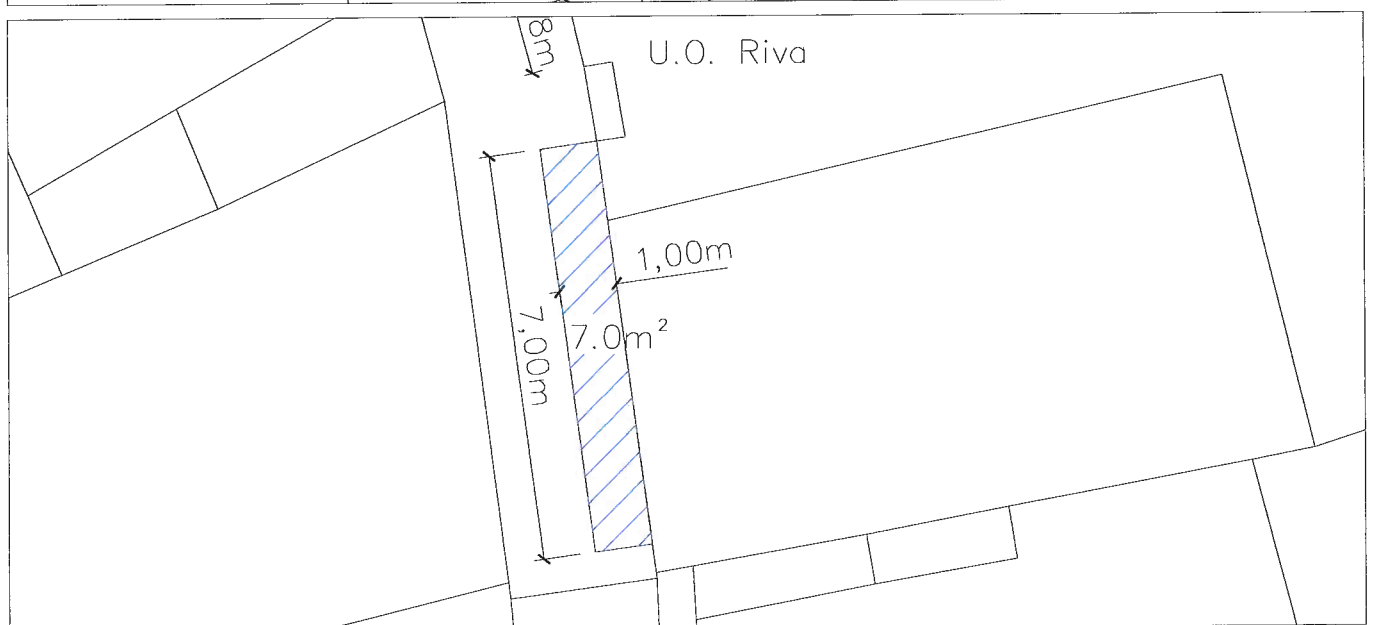
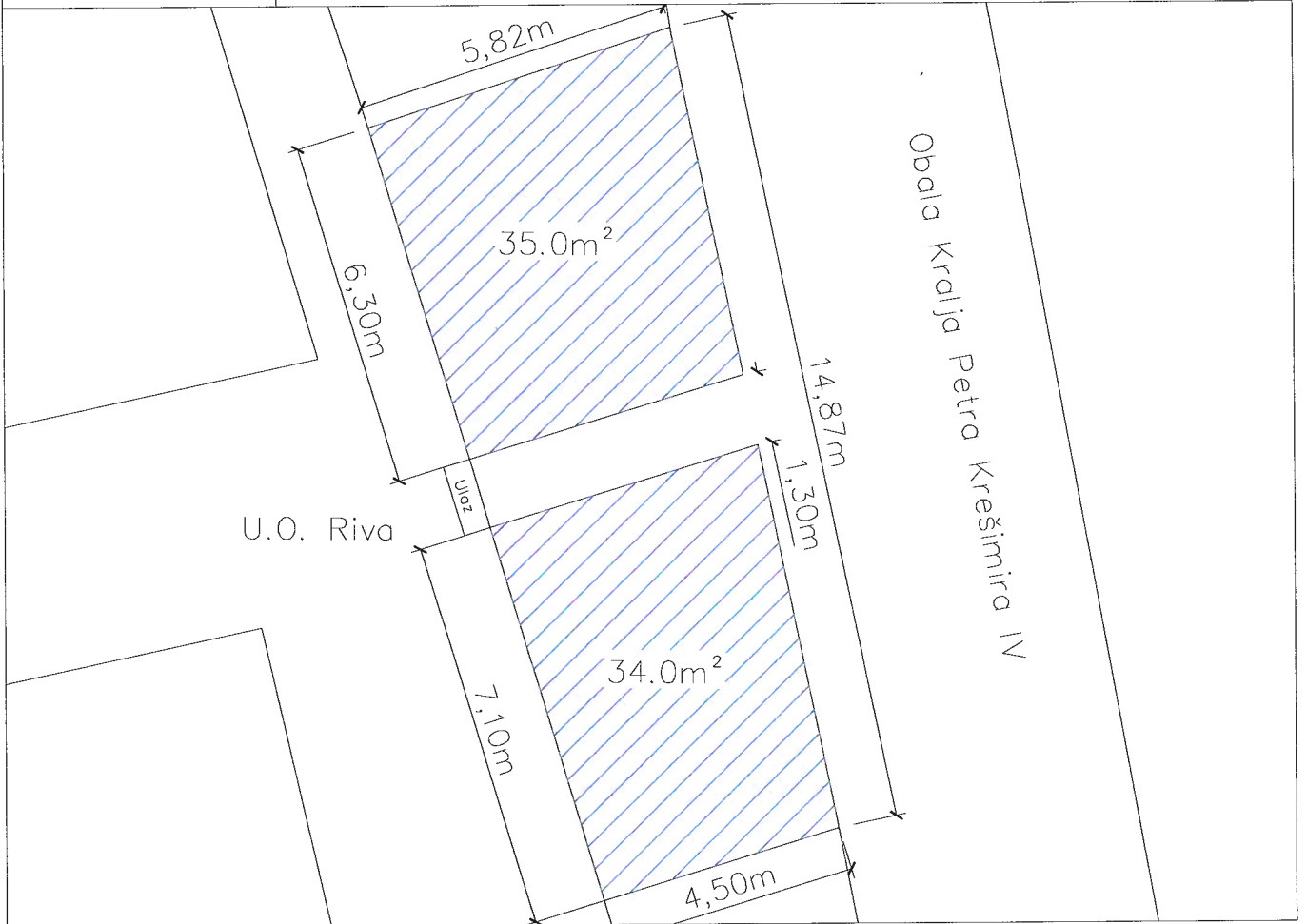

Terasa Broj 15.	Arbiana d.o.o. Obala Kralja Petra Krešimira IV, Ulica Biskupa Draga
K.Č.BR.	2263/3, 2263/33
Zona	0., I.
Kvadratura	32,0m ² , 8,0m ²
Period	Sezonsko

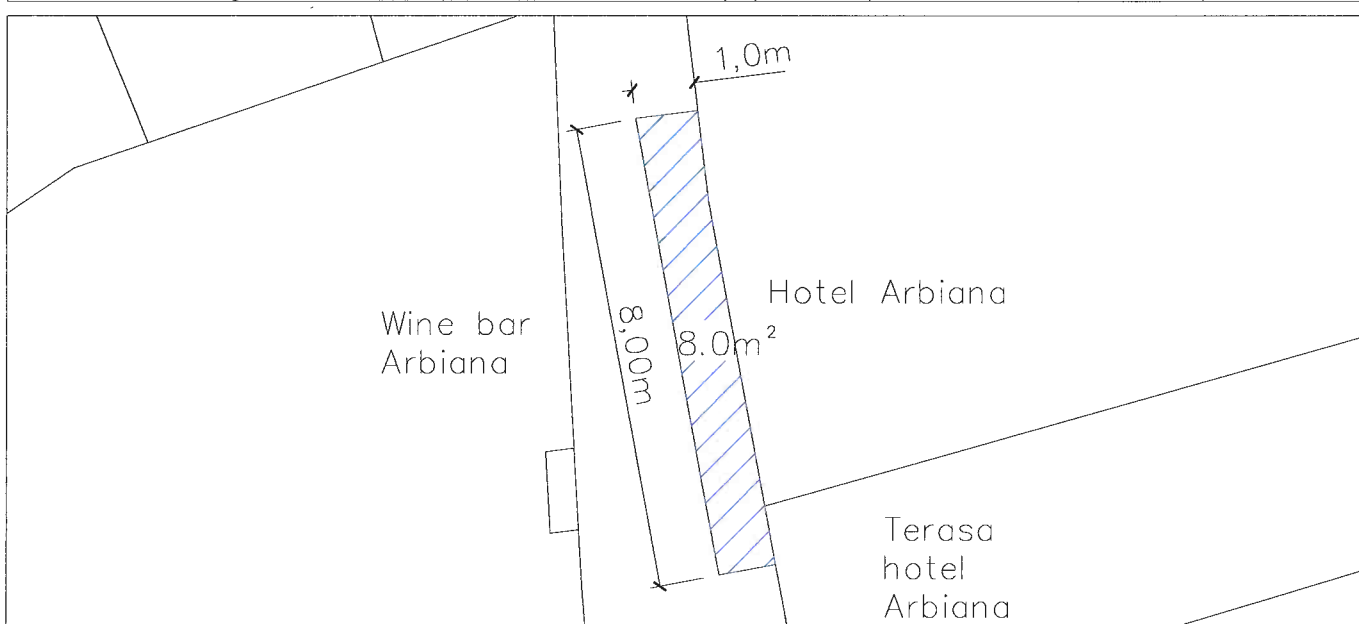
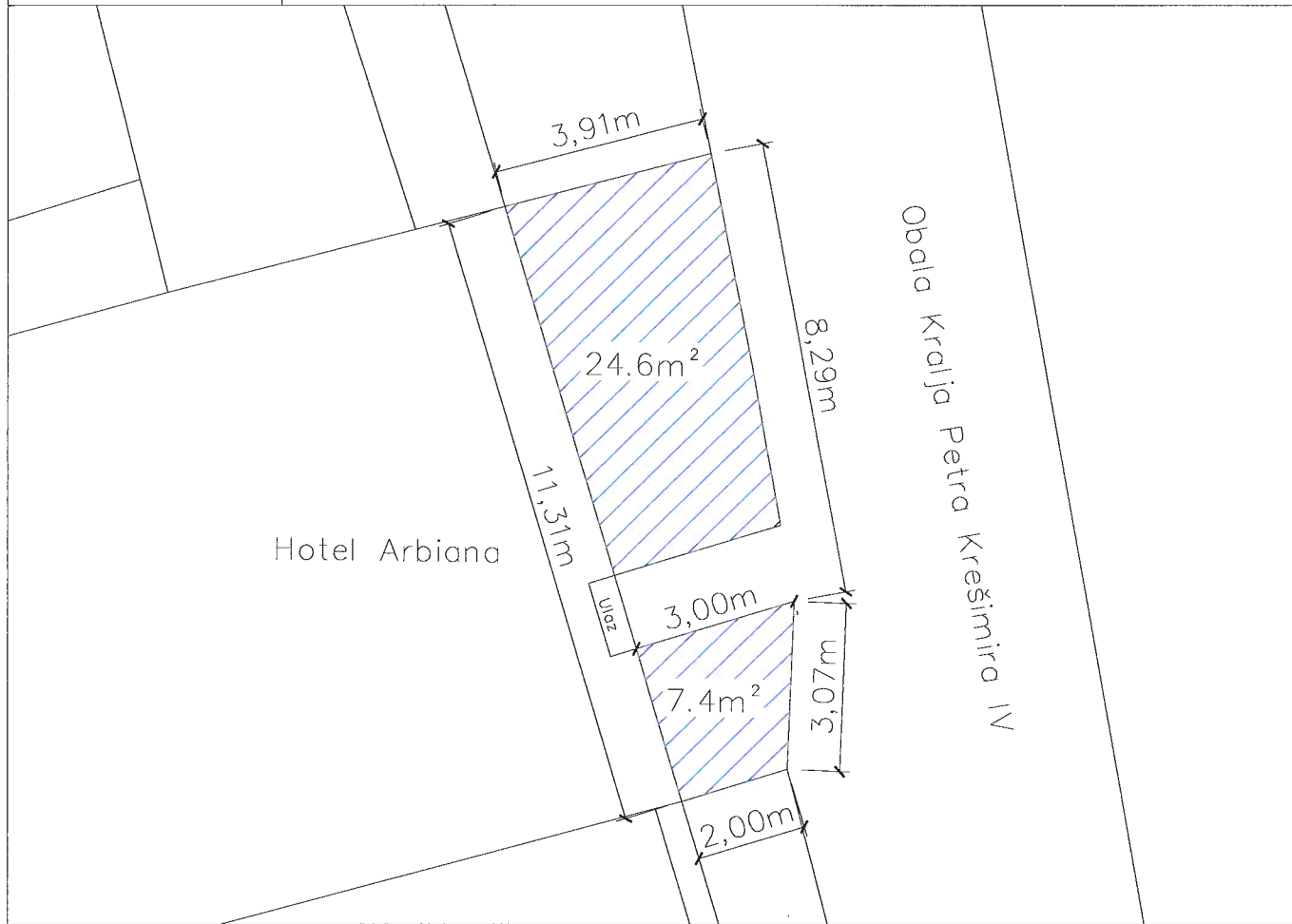

Terasa Broj 16.	U.O. Šanpjer vl. Marica Španjol Obala Kralja Petra Krešimira
K.Č.BR.	2263/1
Zona	0.
Kvadratura	67m ²
Period	sezonsko

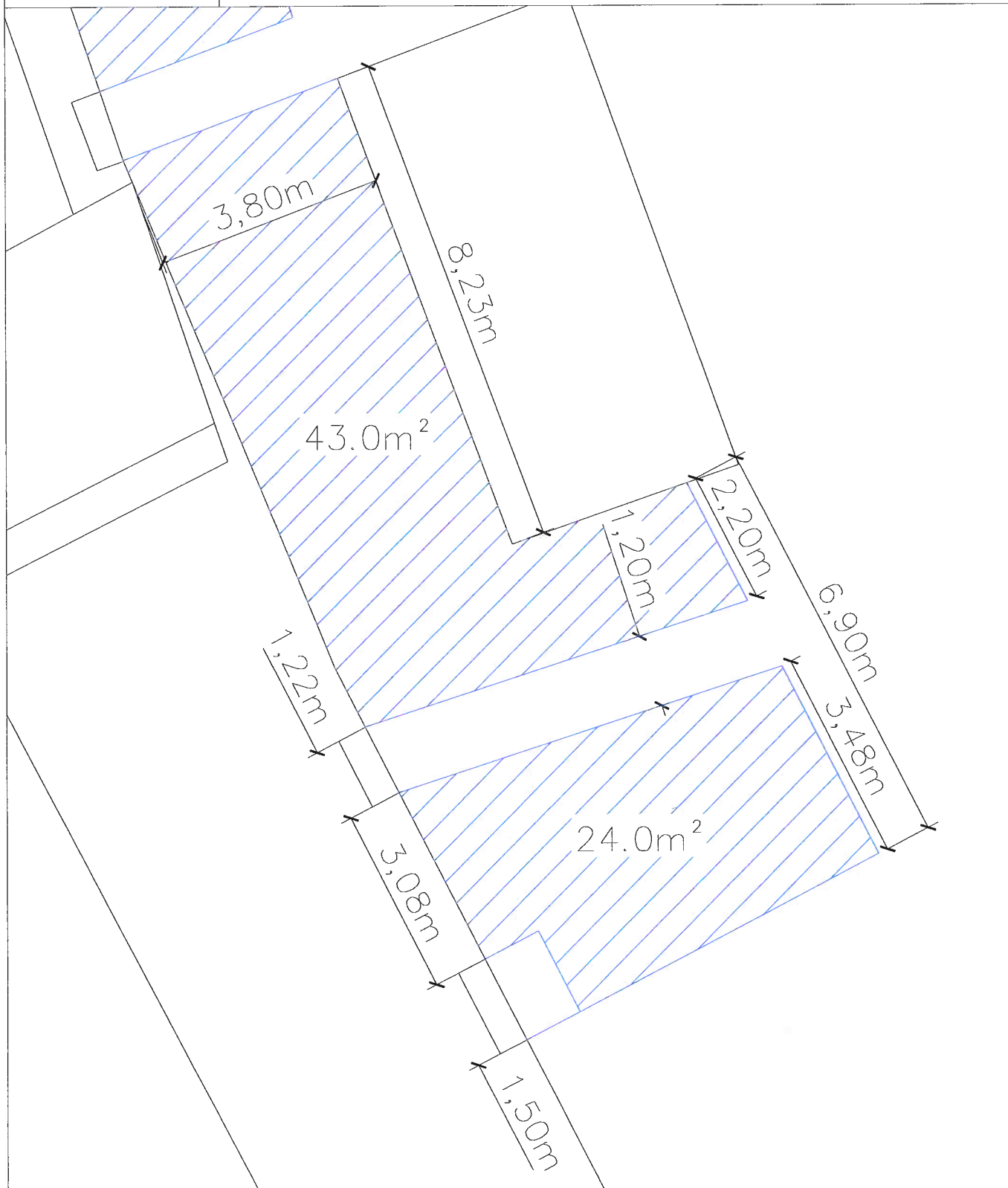

Terasa Broj 17.	Hoteli Rab d.o.o. Obala Kralja Petra Krešimira
K.Č.BR.	2263/1
Zona	0.
Kvadratura	127,0m ²
Period	Sezonsko

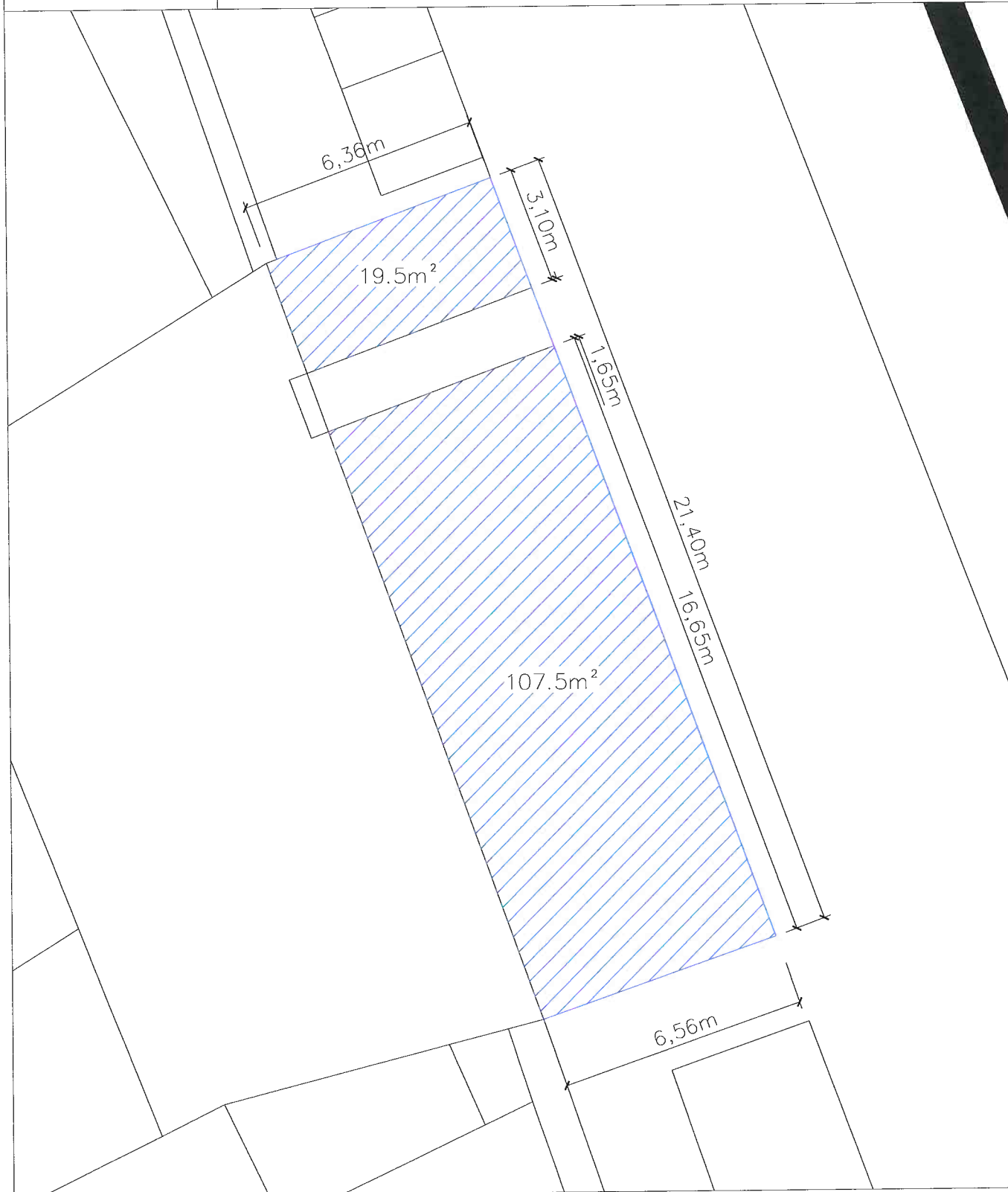

Terasa Broj 18.	Trapp d.o.o. Obala Kralja P. Krešimira IV
K.Č.BR.	2263/1
Zona	0.
Kvadratura	196,4m ² , šank-točionik 5m ²
Period	Cjelogodišnje

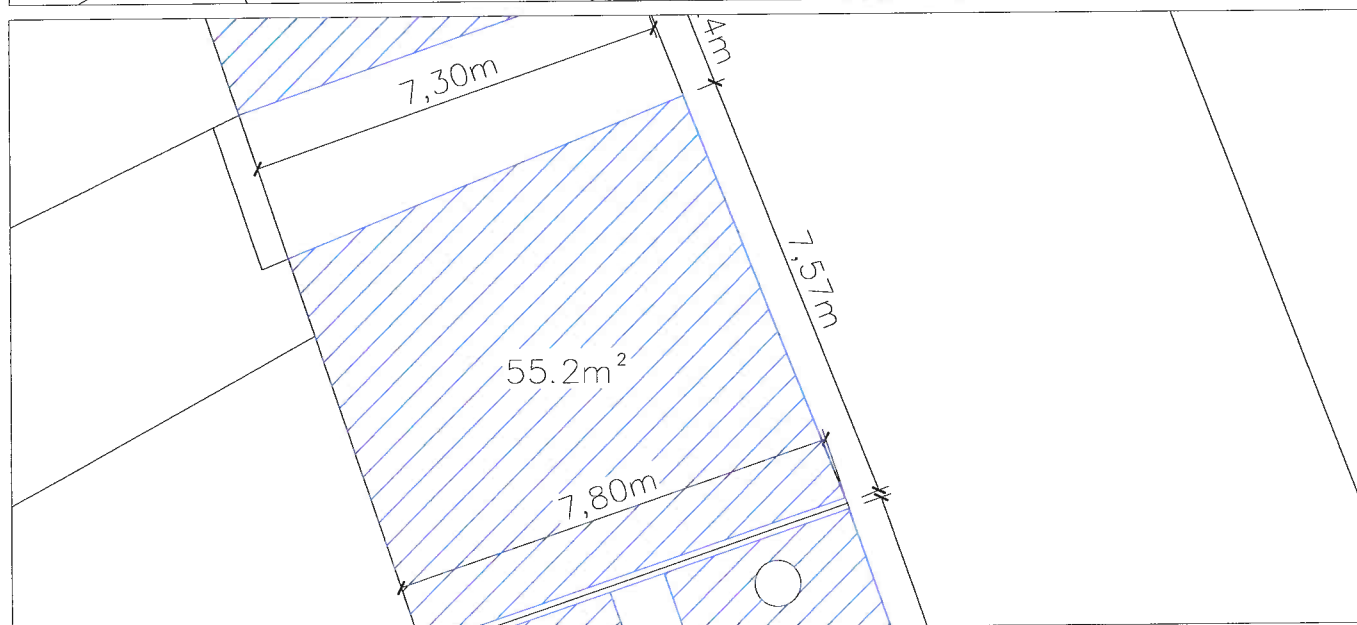

Terasa Broj 19.	Hercules j.d.o.o. Vl. Nenad Trapp Obala Kralja P. Krešimira IV
--------------------	---

K.Č.BR.	2263/1
---------	--------

Zona	0.
------	----

Kvadratura	74,5m ² , šank-točionik 4m ²
------------	--

Period	Cjelogodišnje
--------	---------------

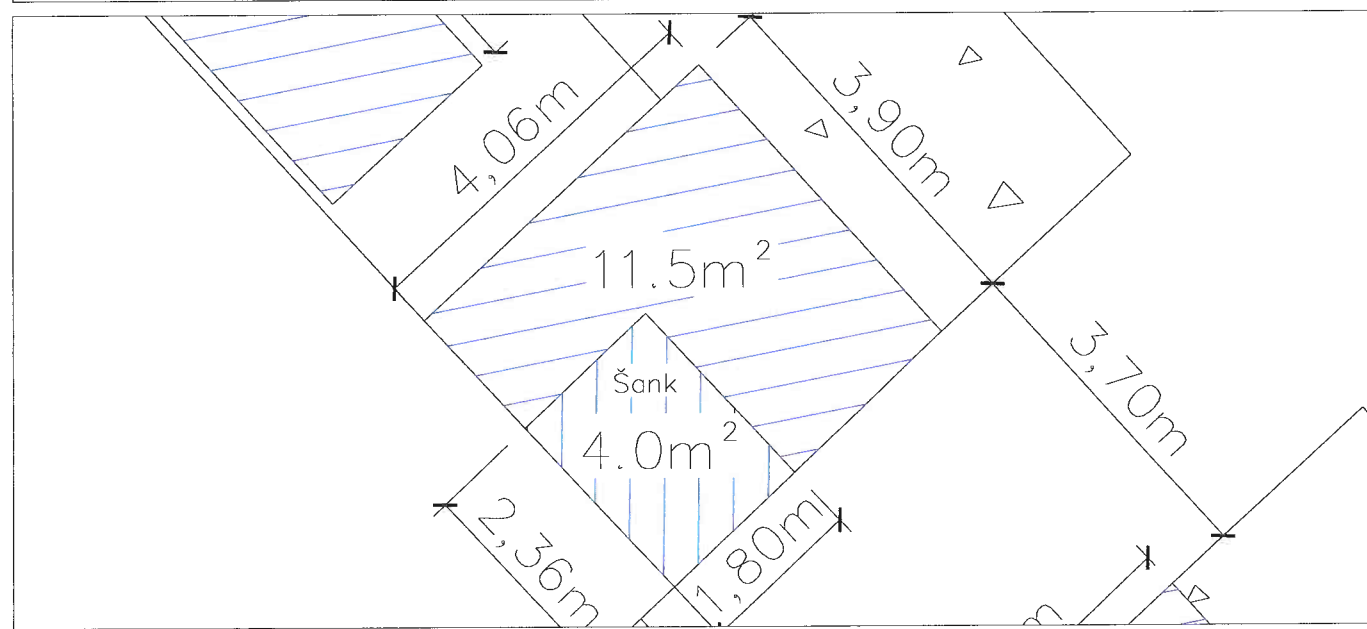
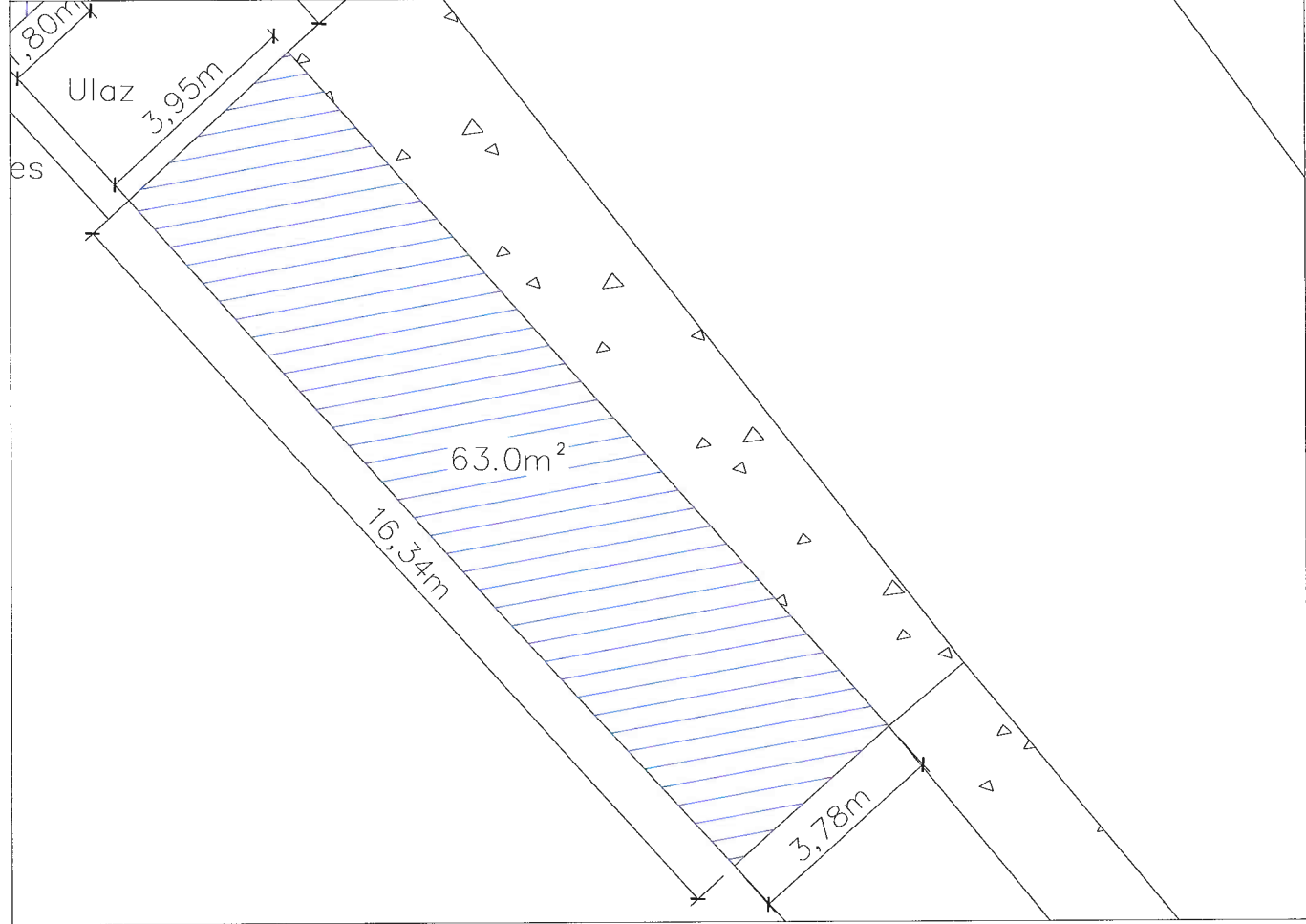

Terasa Broj 20.	Ugo energy d.o.o. vl. Castriot Noshi Obala Kralja P. Krešimira IV
K.Č.BR.	2263/1
Zona	0.
Kvadratura	22,0m ²
Period	Sezonsko

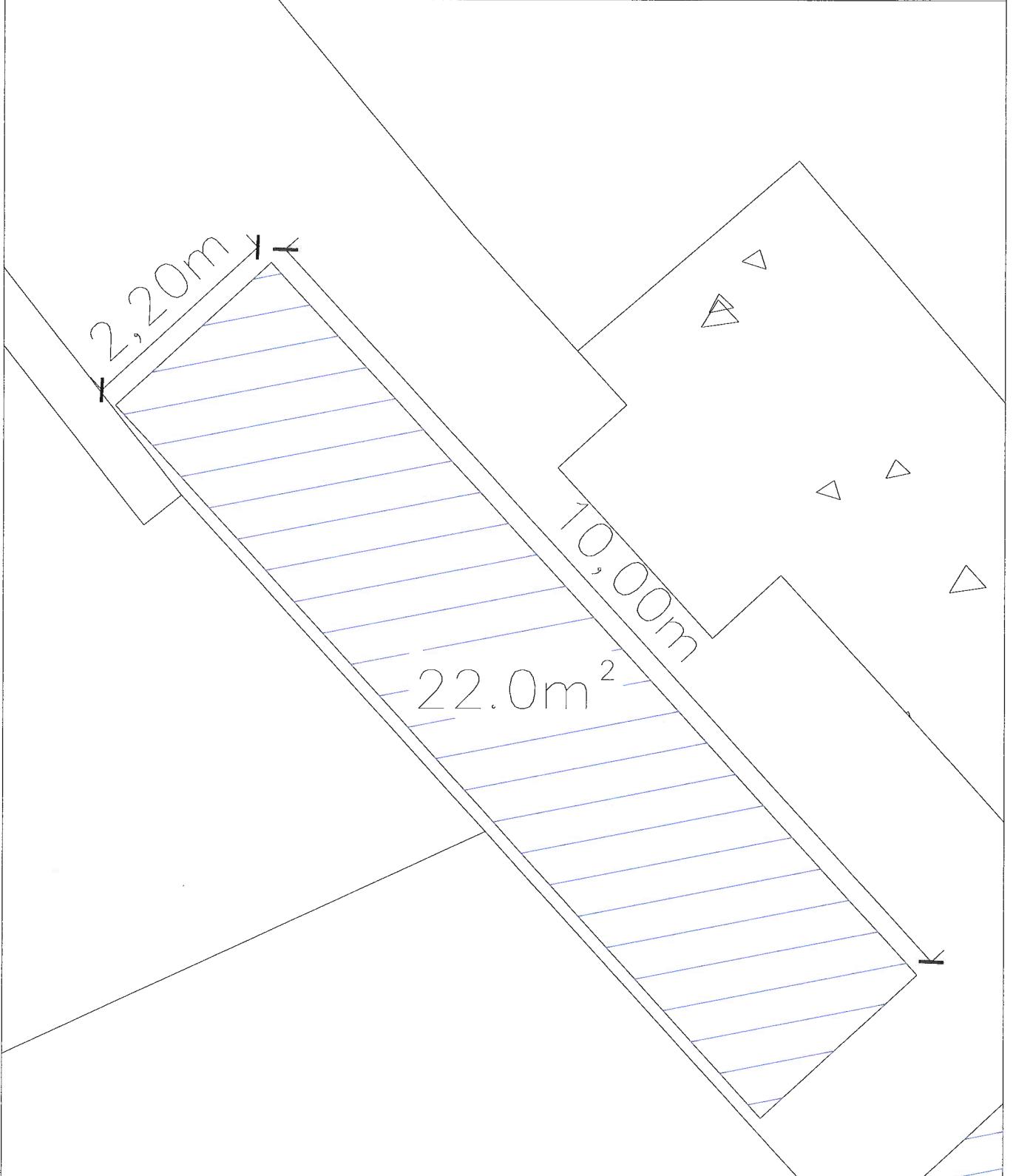

Terasa Broj 21.	U.O. "Šime" vl. Marijan Šimičić Donja Ulica
K.Č.BR.	2263/2
Zona	I.
Kvadratura	35m ²
Period	sezonsko

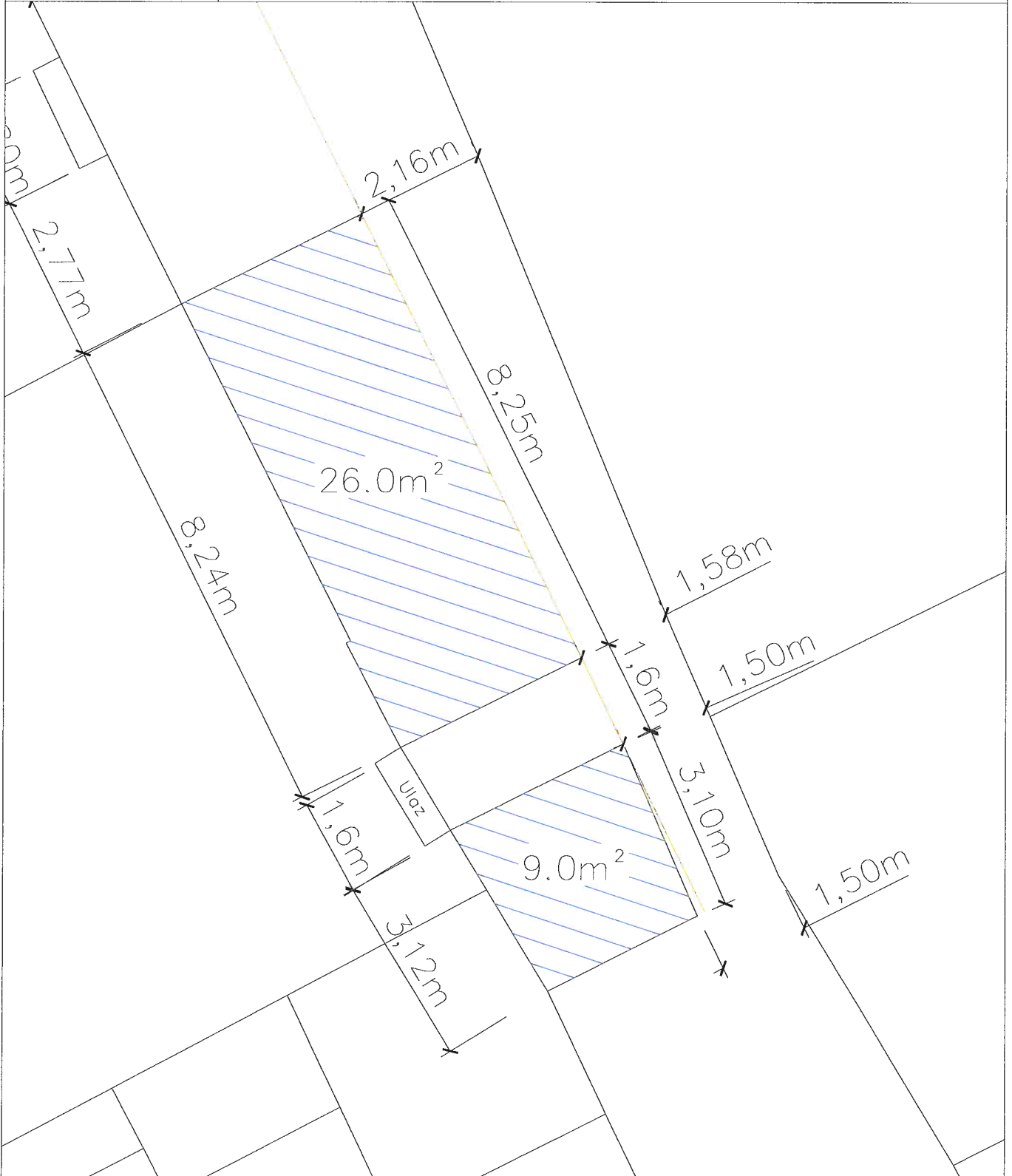

Terasa Broj 22.	U.O. Korzo VI. Rifet Idrizi Ul Kneza Trpimira, prolaz između Srednje i Donje ulice
K.Č.BR.	2263/48, 2263/47
Zona	I.
Kvadratura	17m ² , šank-točionik 1m ²
Period	Sezonsko

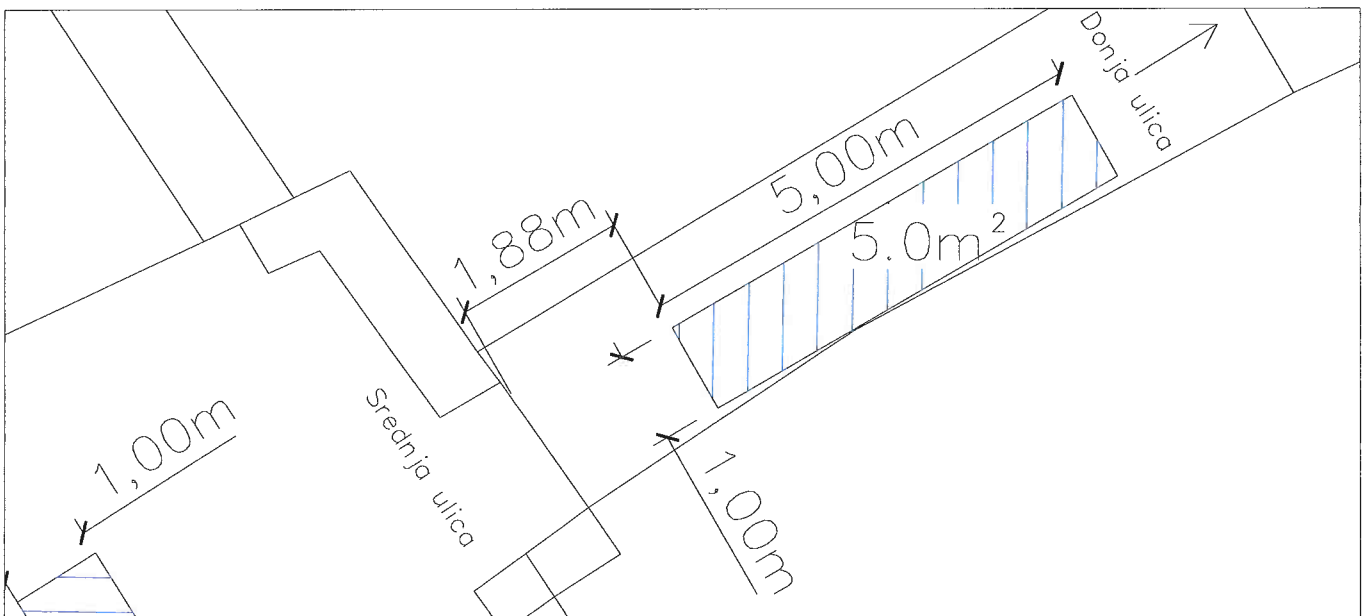
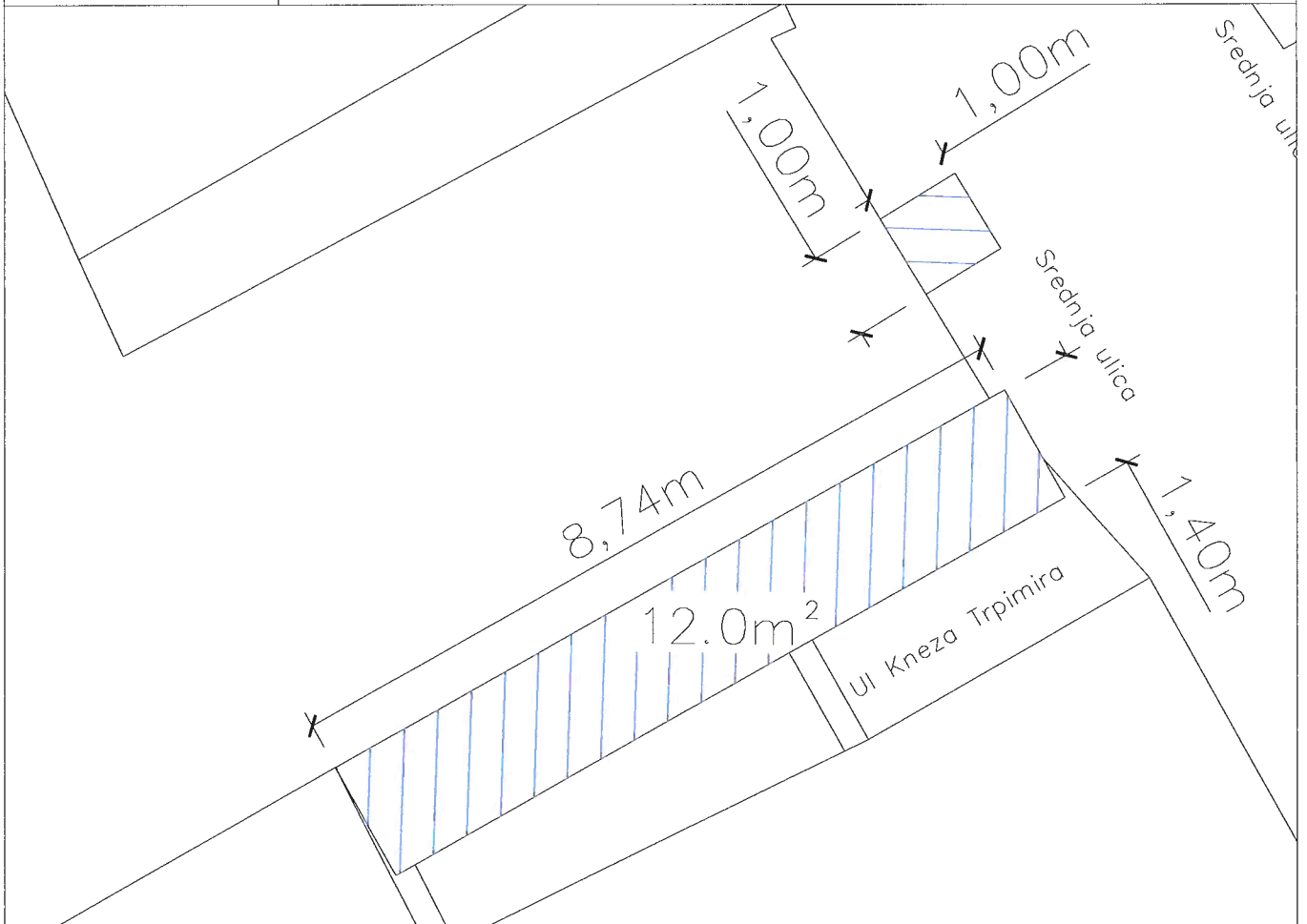

Terasa Broj 23.	U.O. San Marco VI. Zoran Arsić Ul. Rapske brigade
K.Č.BR.	2263/20
Zona	I.
Kvadratura	10,0m ²
Period	Sezonsko

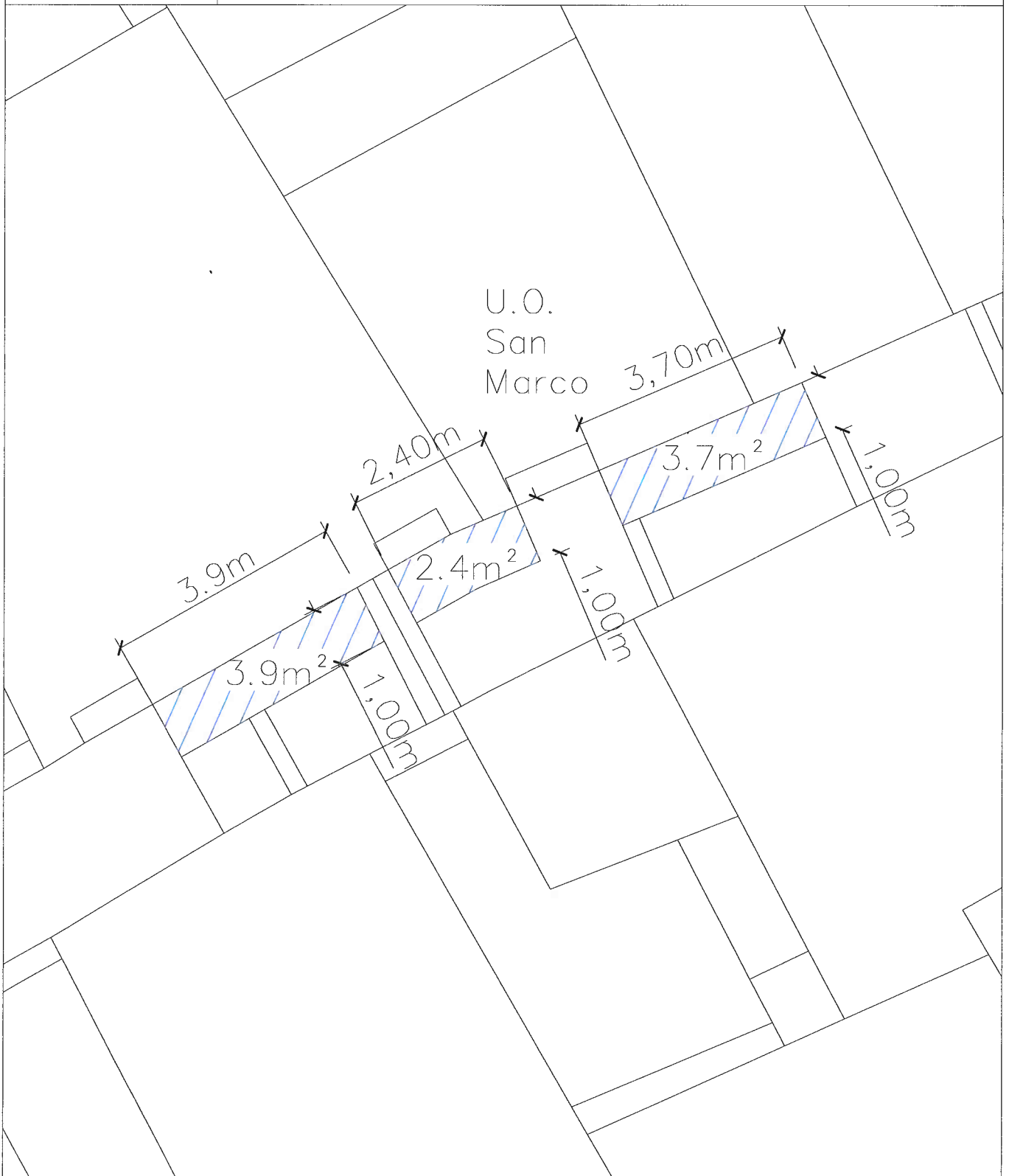

Terasa Broj 24.	U.O Starčević Vl. Nedeljka Perkić Kneza Domagoja
K.Č.BR.	2263/24
Zona	I.
Kvadratura	5,0m ²
Period	Sezonsko

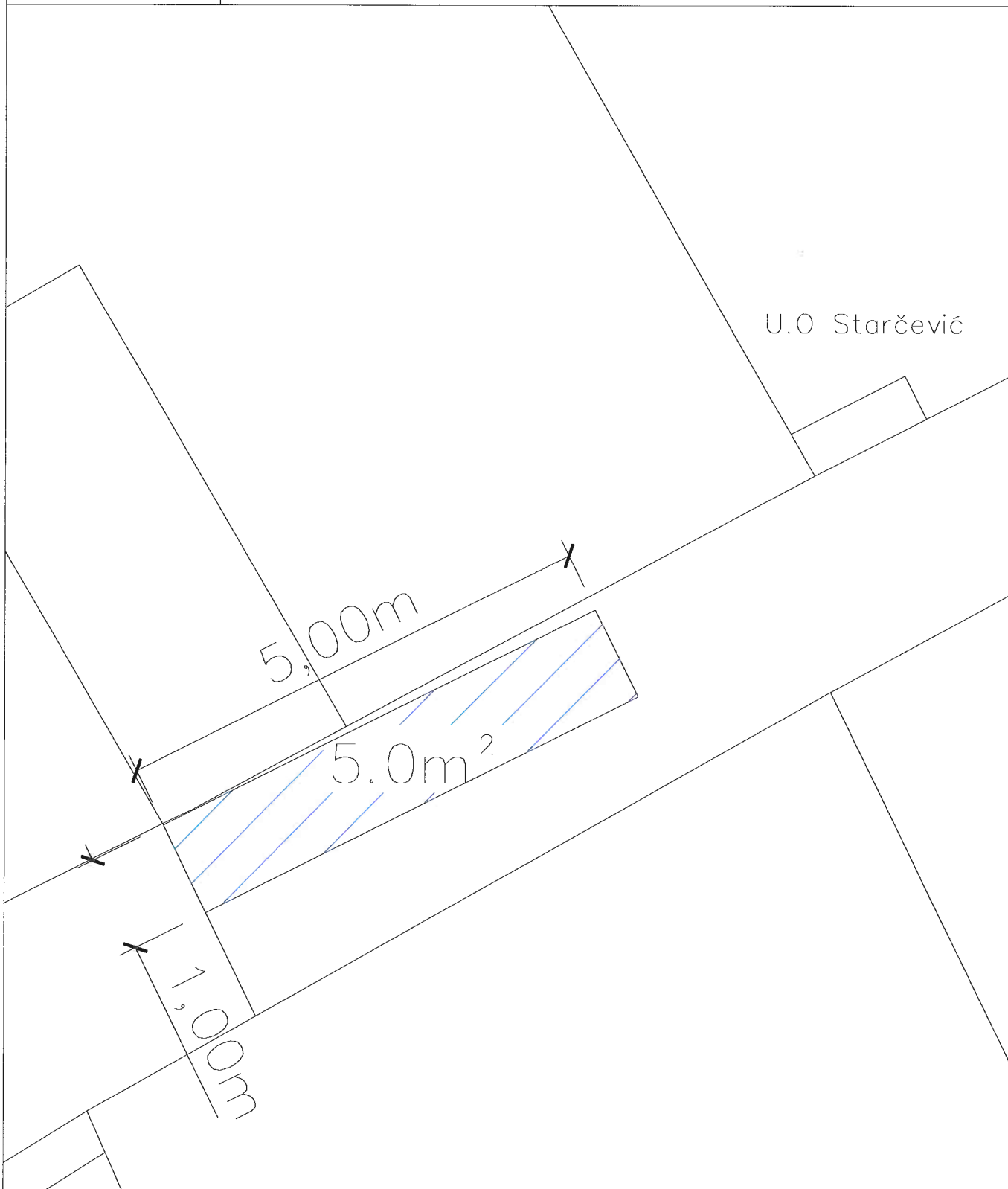

Terasa Broj 25.	U.O Astoria Vl. Larisa Jaška Ulica Biskupa Draga
K.Č.BR.	2263/33
Zona	I.
Kvadratura	35,0m ²
Period	Sezonsko

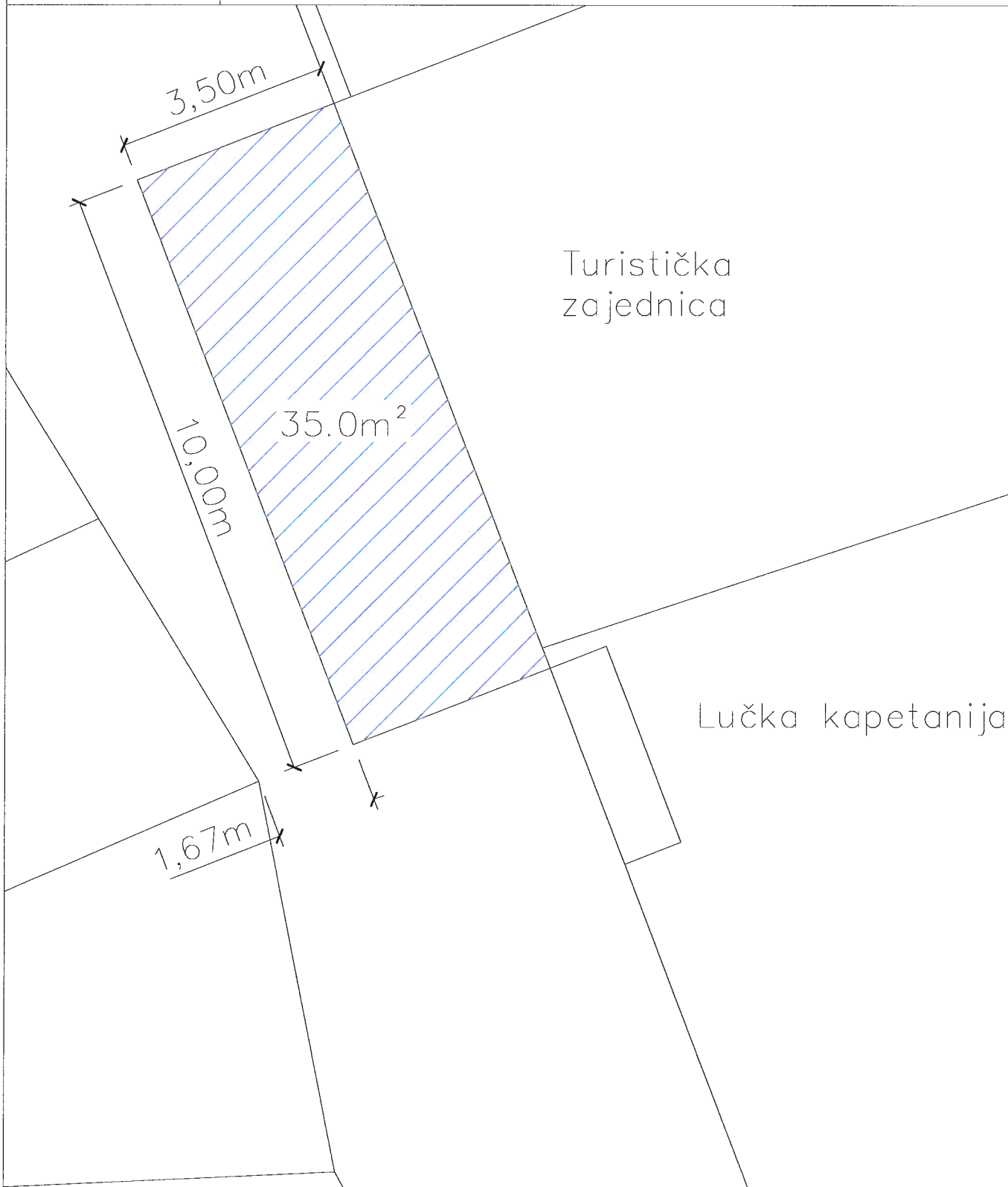

Terasa Broj 26.	U.O Zlatni rab VI. Kamber Šabani Jurja Barakovića
K.Č.BR.	137/10
Zona	I.
Kvadratura	42,0m ²
Period	Sezonsko

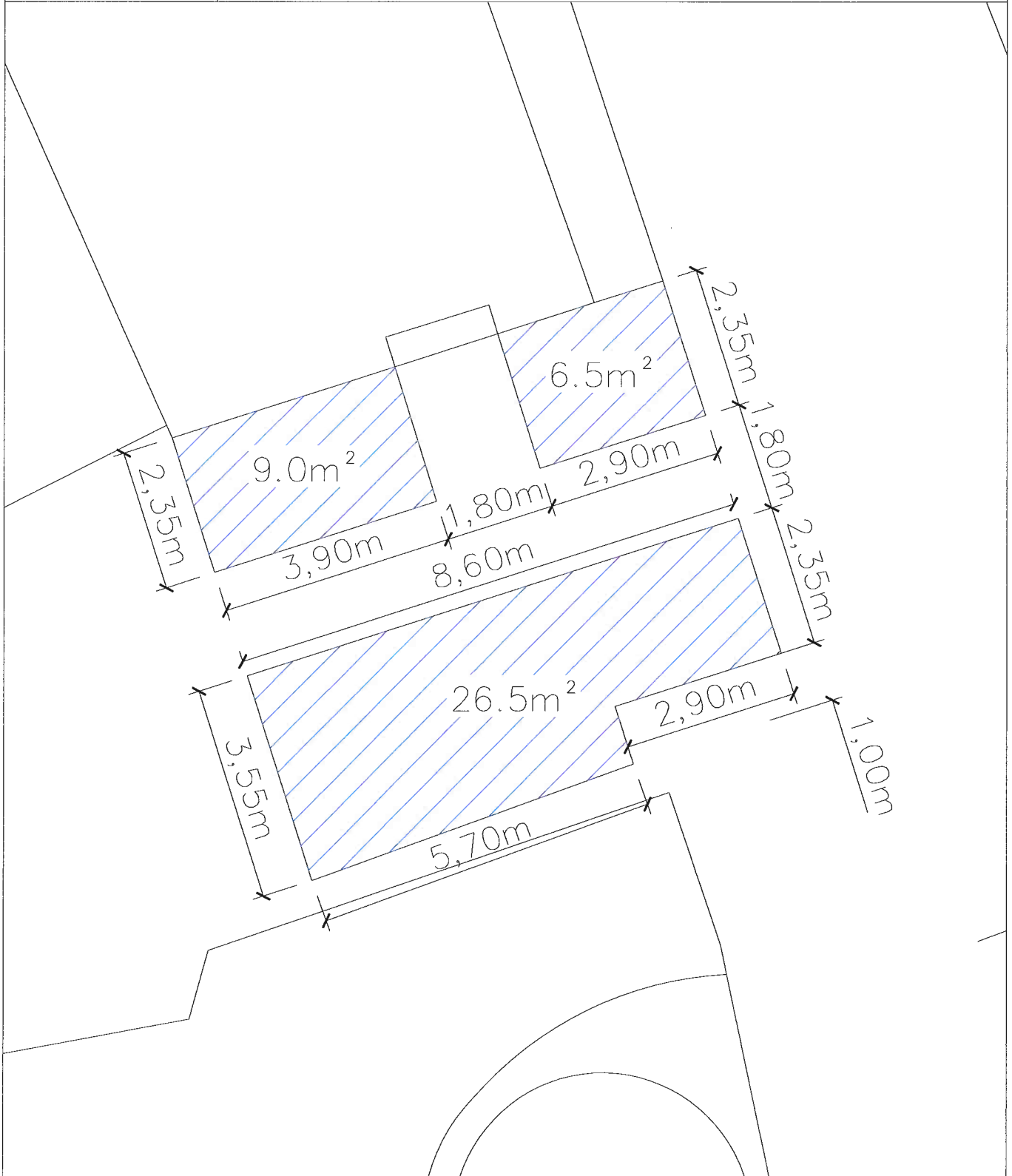

Terasa Broj 27.	Z.U.O. H&J HARPUN VI. Jetmir Zilbeari i Hasan Haki Donja Ulica
K.Č.BR.	2263/2
Zona	I.
Kvadratura	50,0m ²
Period	Sezonsko

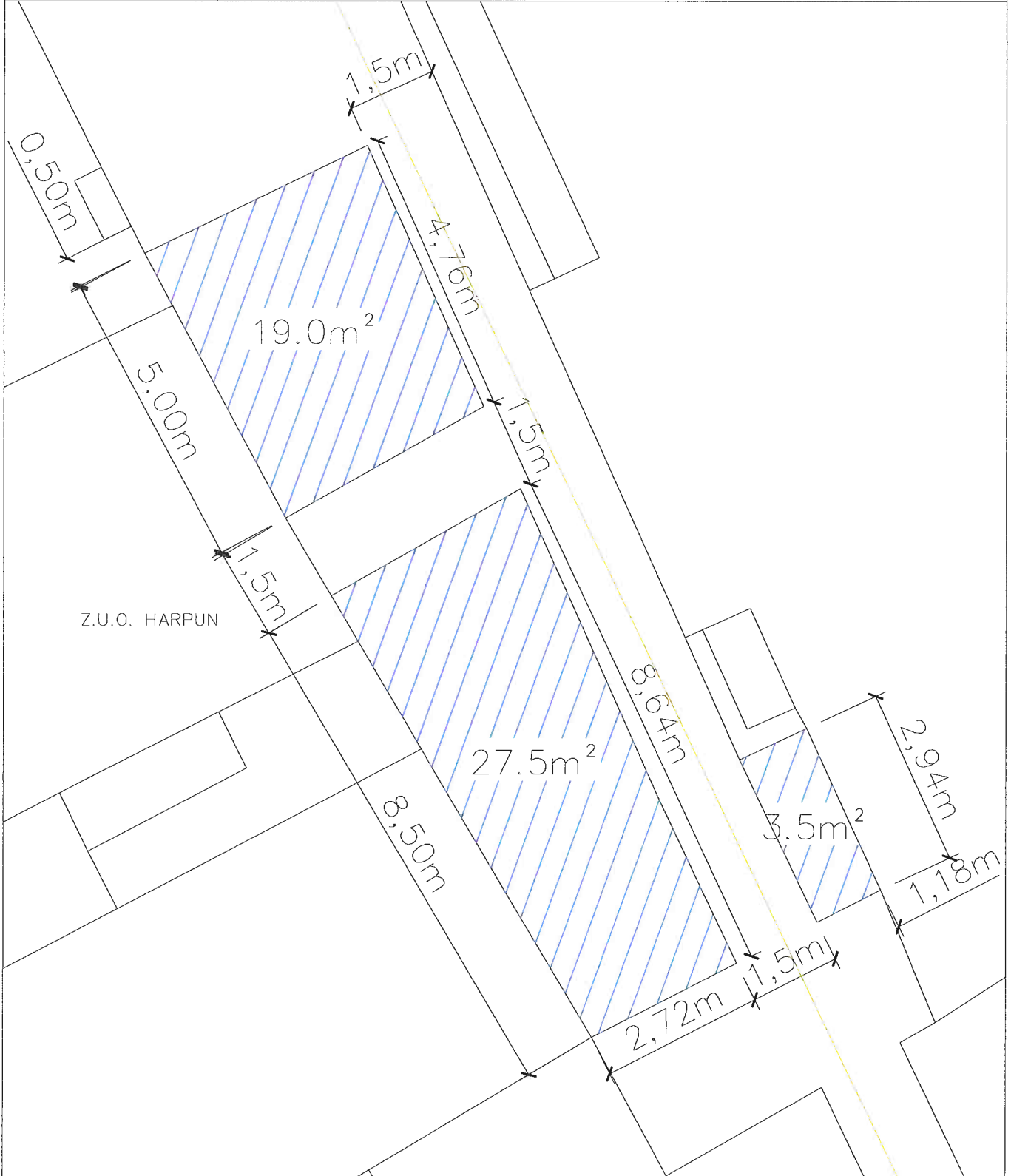

Terasa Broj 28.	Z.U.O. H&J HARPUN VI. Jetmir Zilbeari i Hasan Haki Ulica Biskupa Draga "Kaldanac"
K.Č.BR.	2263/33
Zona	I.
Kvadratura	36,0m ²
Period	Sezonsko

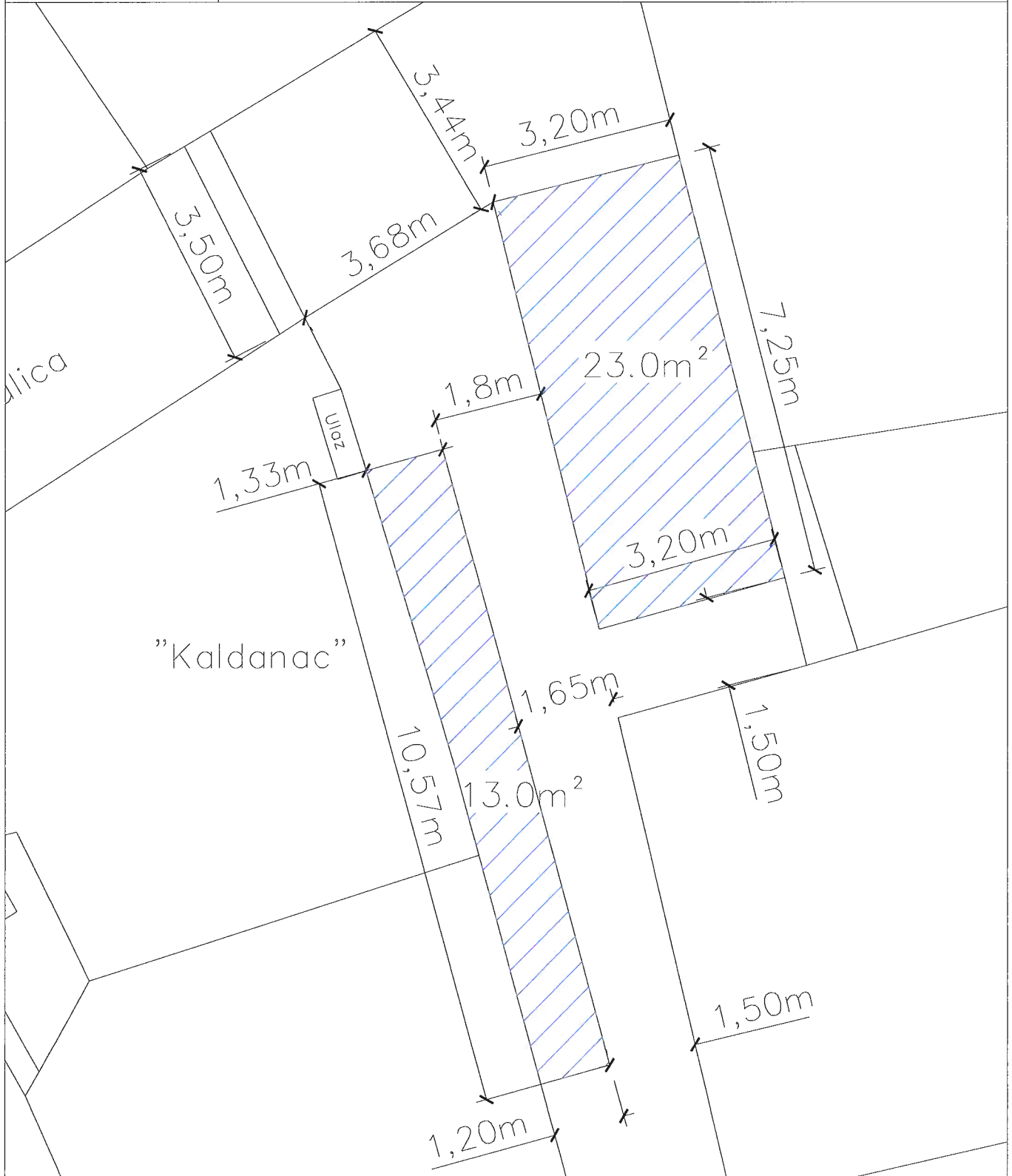

Terasa Broj 29.	Fidem Arba d.o.o. Vl. Noshi Dugaxhin Dinka Dokule
K.Č.BR.	2263/35
Zona	I.
Kvadratura	20,0m ²
Period	Sezonsko

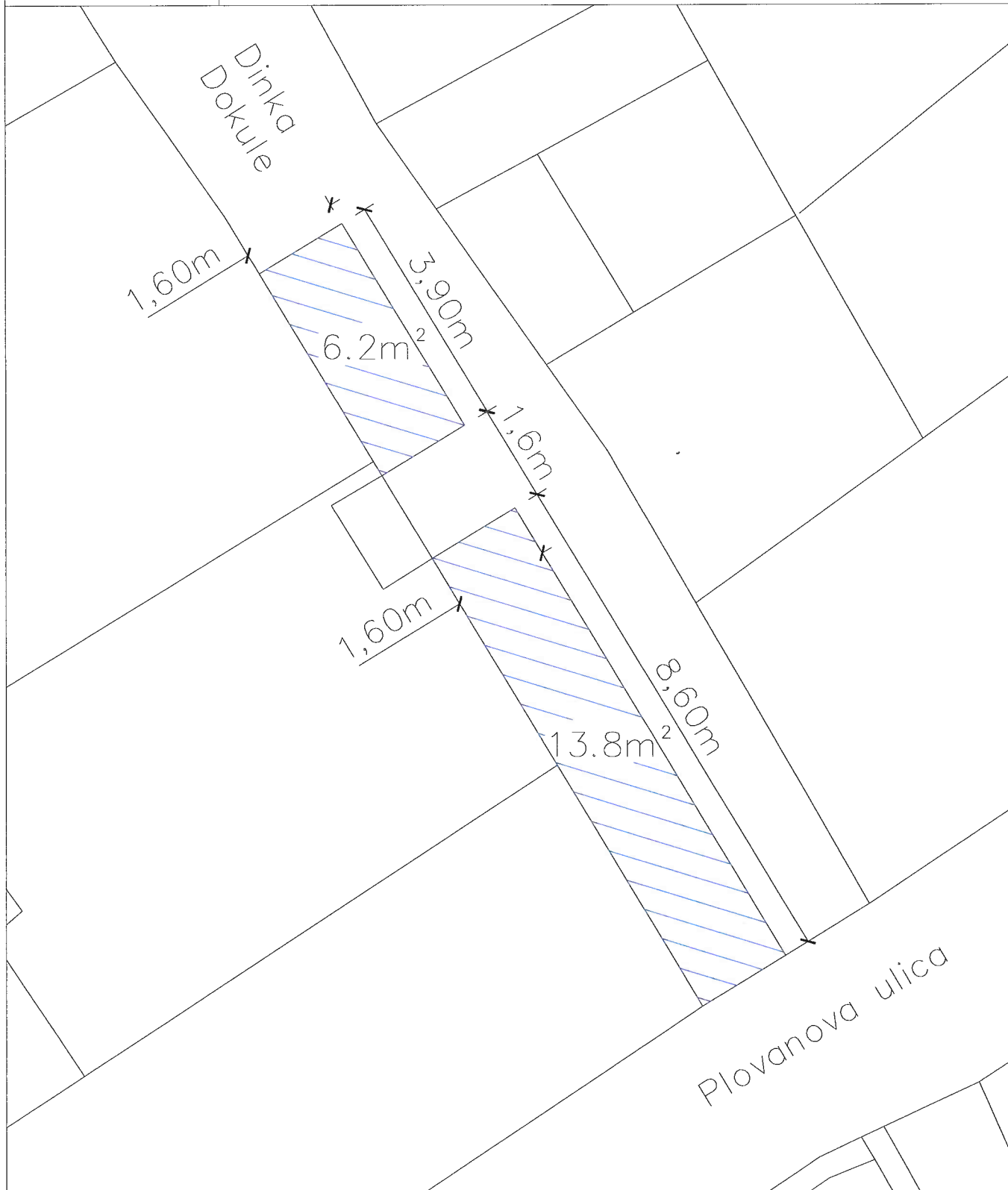

Terasa Broj 30.	Obrt "Gušt" Rab VI. Ante Verović Dinka Dokule
K.Č.BR.	2263/35
Zona	I.
Kvadratura	4,0m ²
Period	Sezonsko

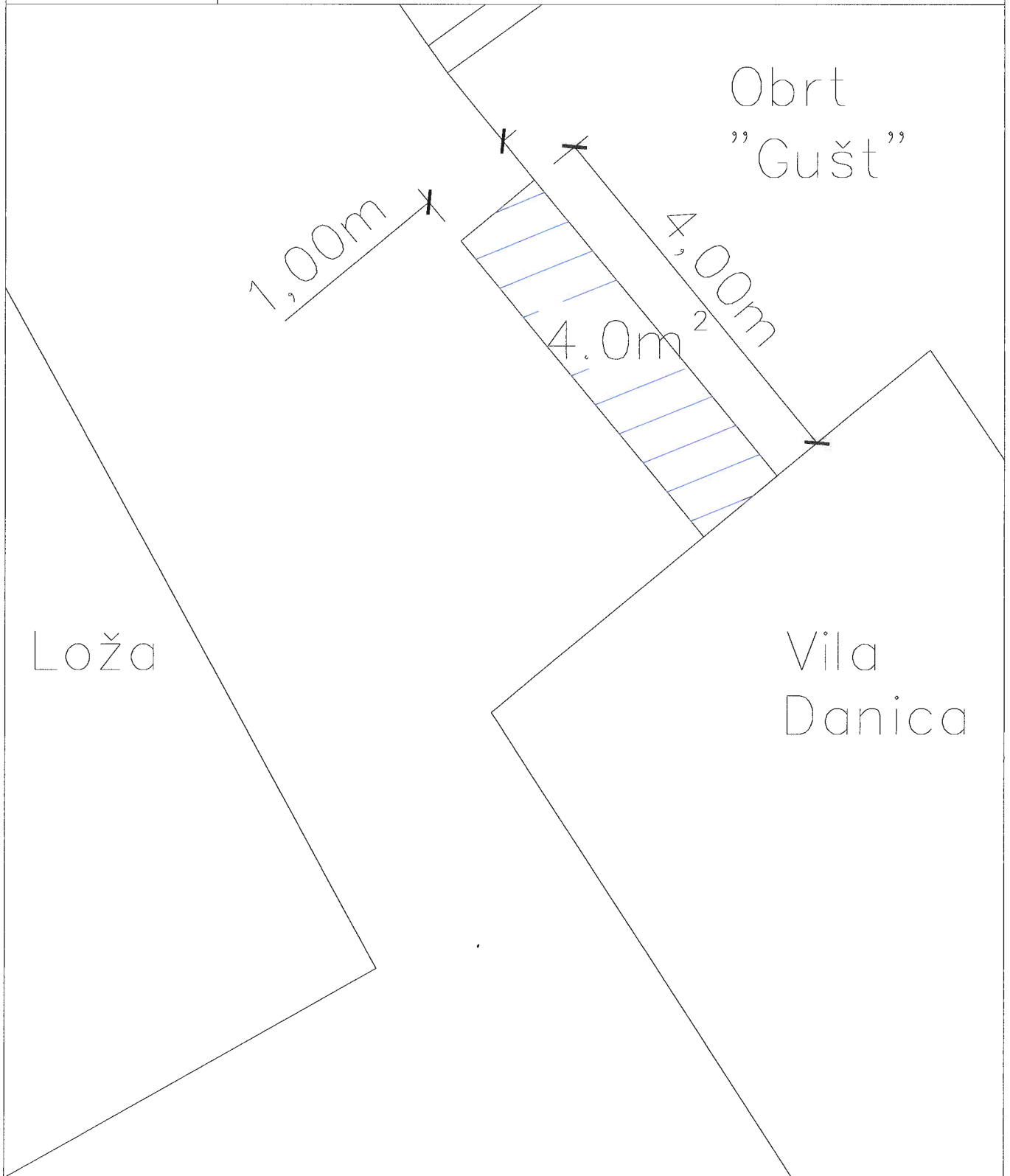

Terasa Broj 31.	Ugostiteljski obrt D&S vl Davor Faflja Ulica A. Ugalje
K.Č.BR.	2263/51
Zona	I.
Kvadratura	12,8m ²
Period	cjelogodišnje

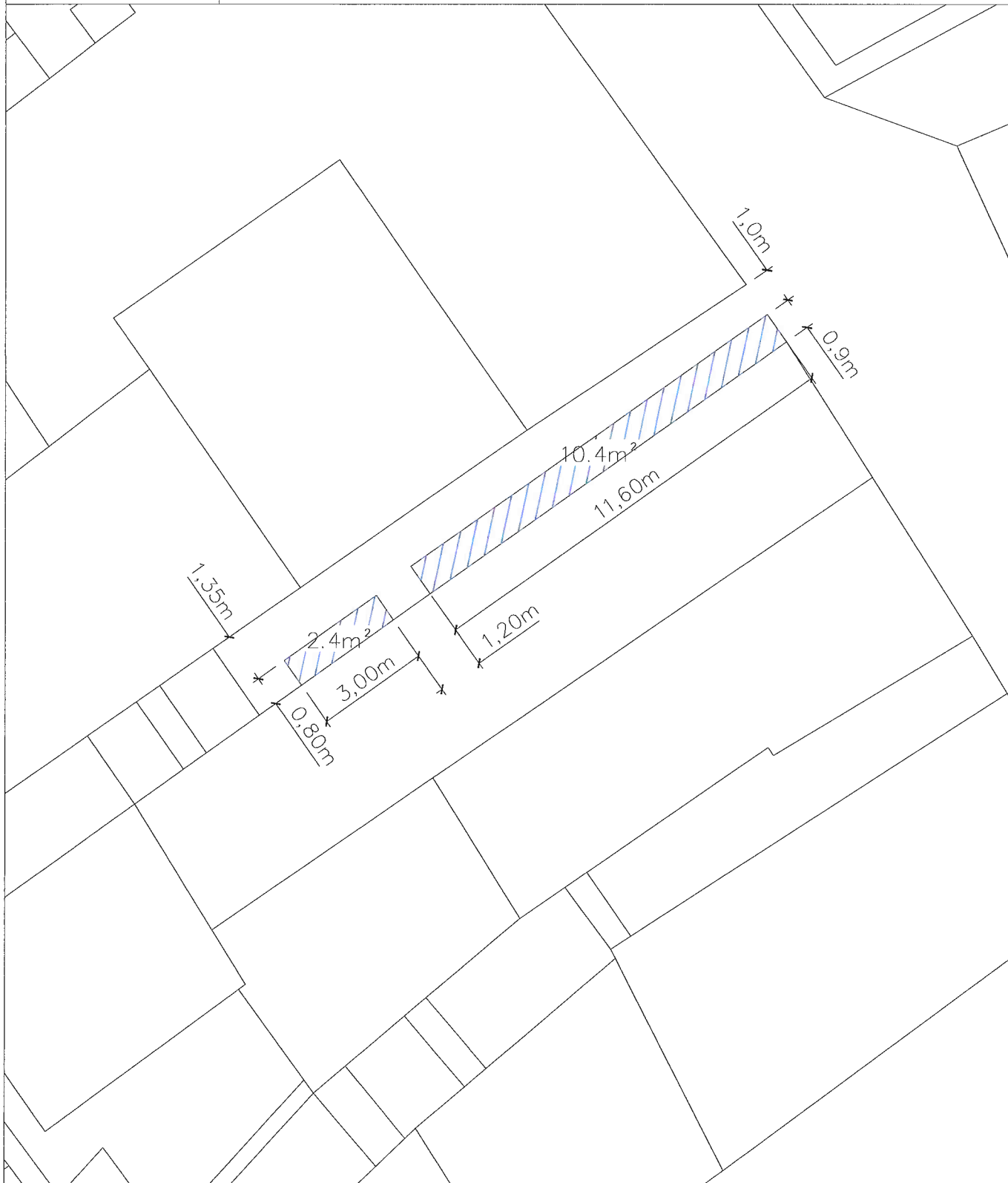

Terasa Broj 32.	Vilma Slastice d.o.o. VI. Jospi Brna Ul. Stjepana Radića
K.Č.BR.	2263/26
Zona	I.
Kvadratura	19,9m ²
Period	Cjelogodišnje

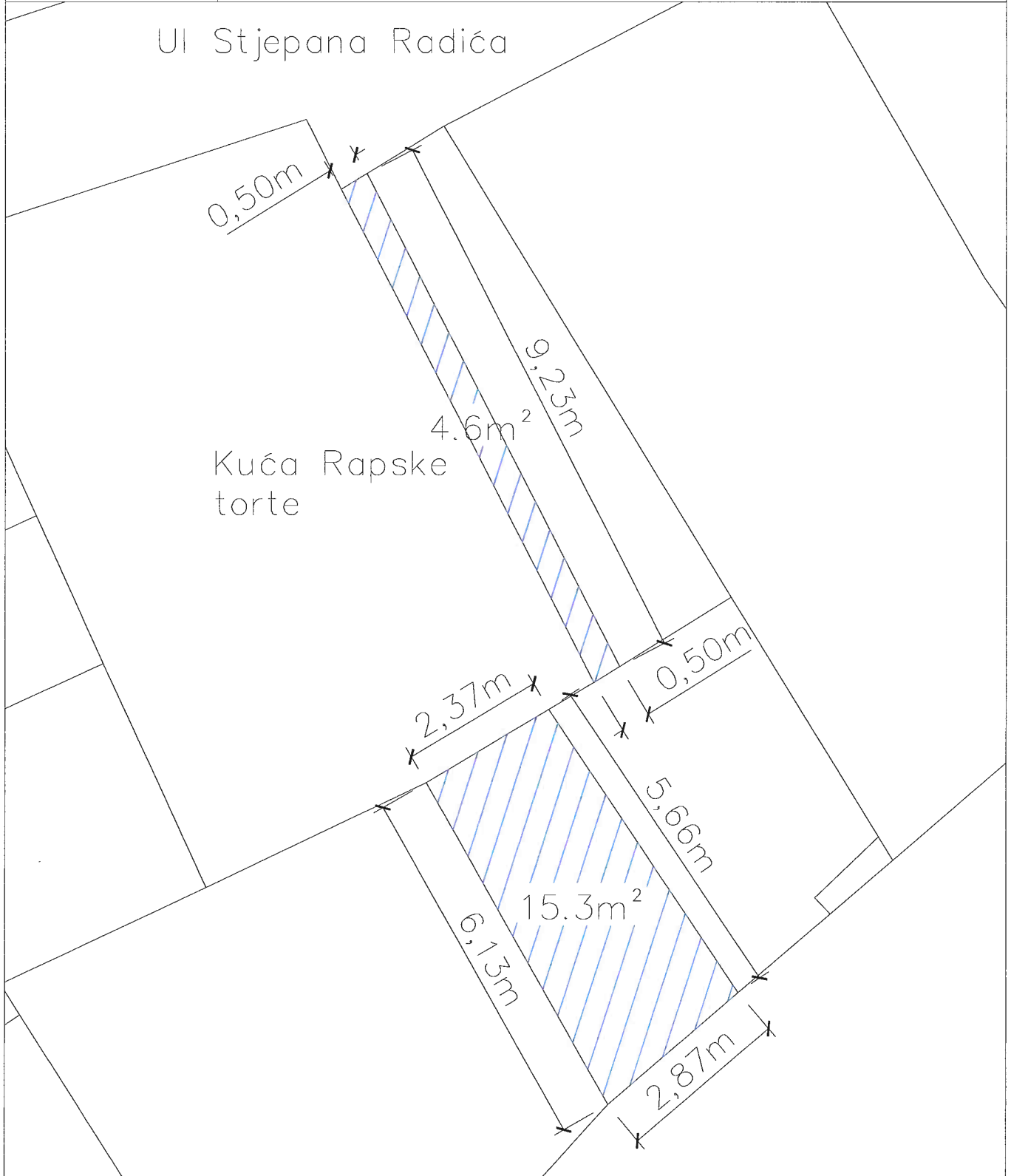

Terasa Broj 33.	U.O. Celestina VI. Ivana Matić Ul. Biskupa Draga
K.Č.BR.	2263/33
Zona	I.
Kvadratura	45,0m ²
Period	Sezonsko

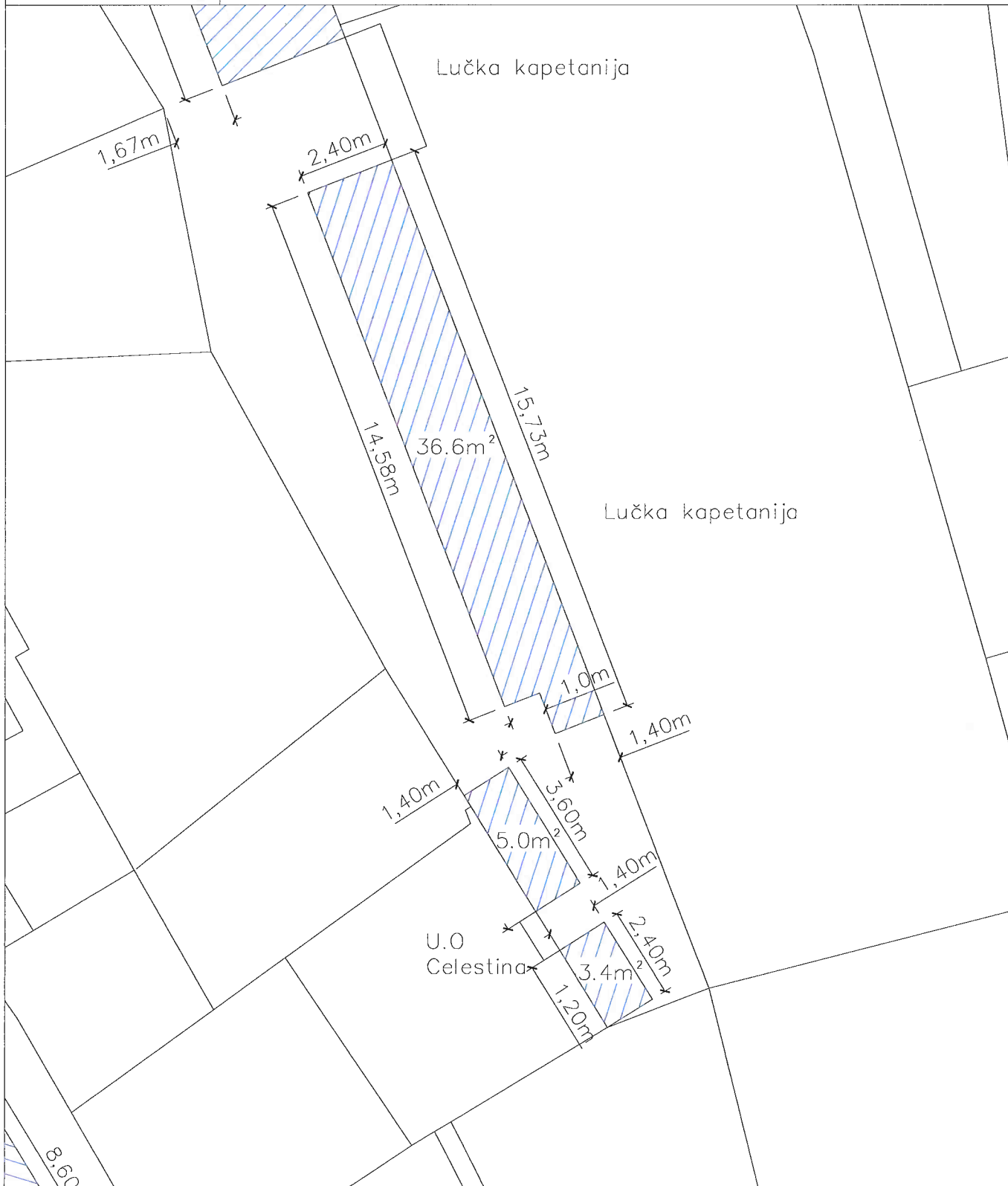

Terasa Broj 34.	Top Point d.o.o. "Burger Point" Jurja Barakovića
K.Č.BR.	2263/54
Zona	I.
Kvadratura	17,0m ²
Period	Cjelogodišnje

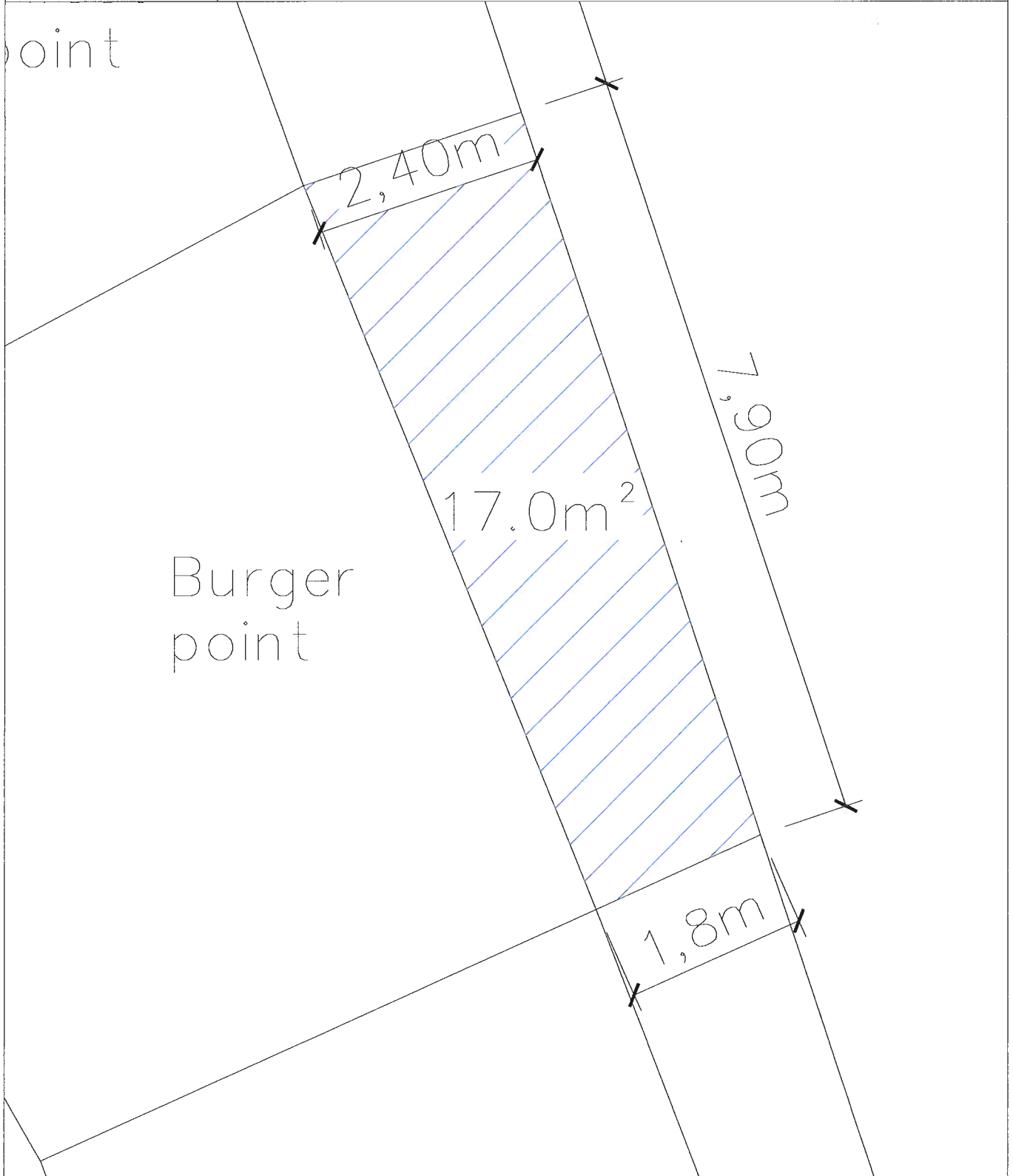

Terasa Broj 35.	Top Point d.o.o. "Sweet Point" Jurja Barakovića
K.Č.BR.	2263/54
Zona	I.
Kvadratura	13,0m ²
Period	Cjelogodišnje

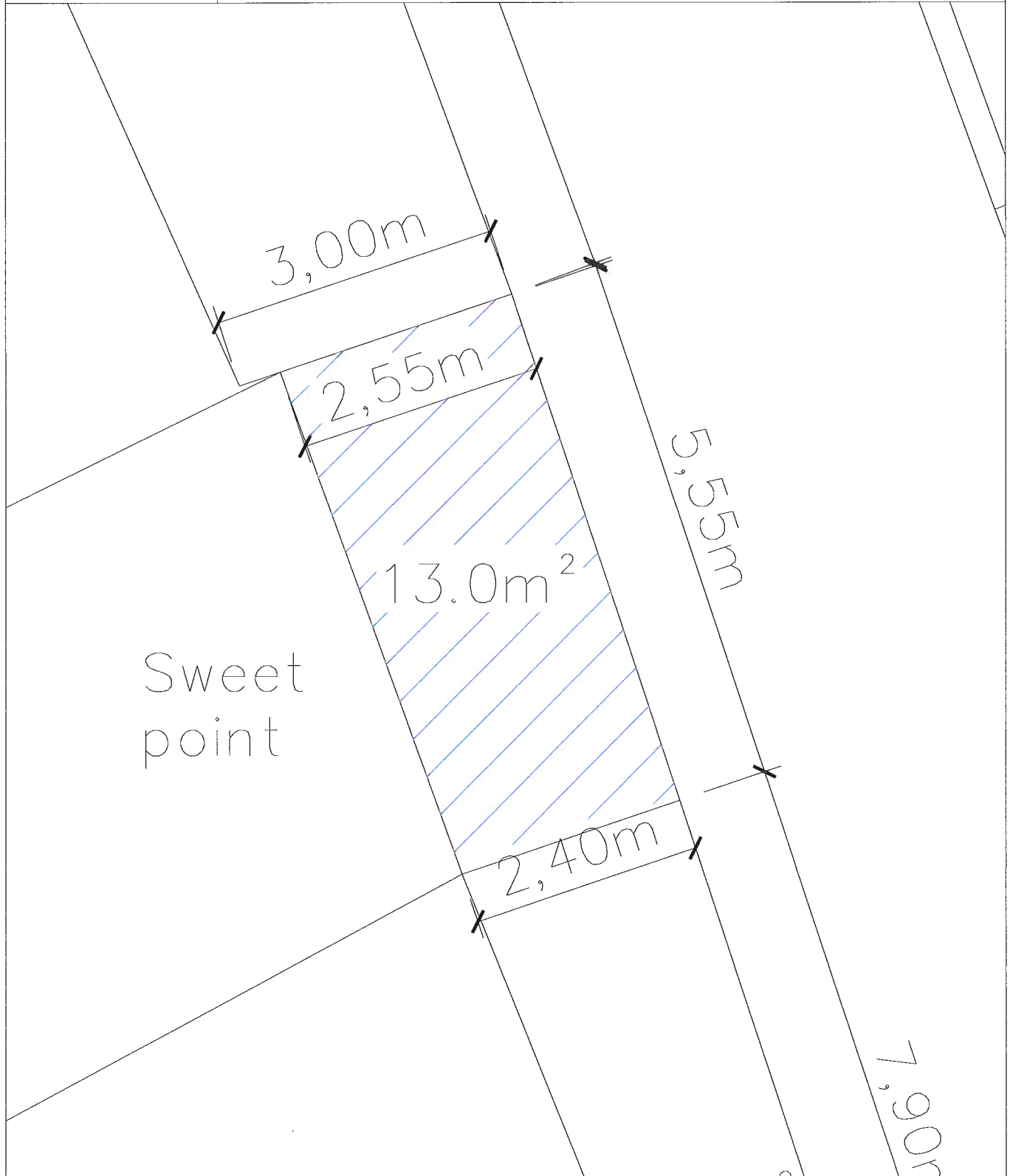

Terasa Broj 36.	U.O. Forum VI. Keko Nenad Jurja Barakovića
K.Č.BR.	2263/2
Zona	I.
Kvadratura	36,0m ² , šank 4,5m ²
Period	Cjelogodišnje

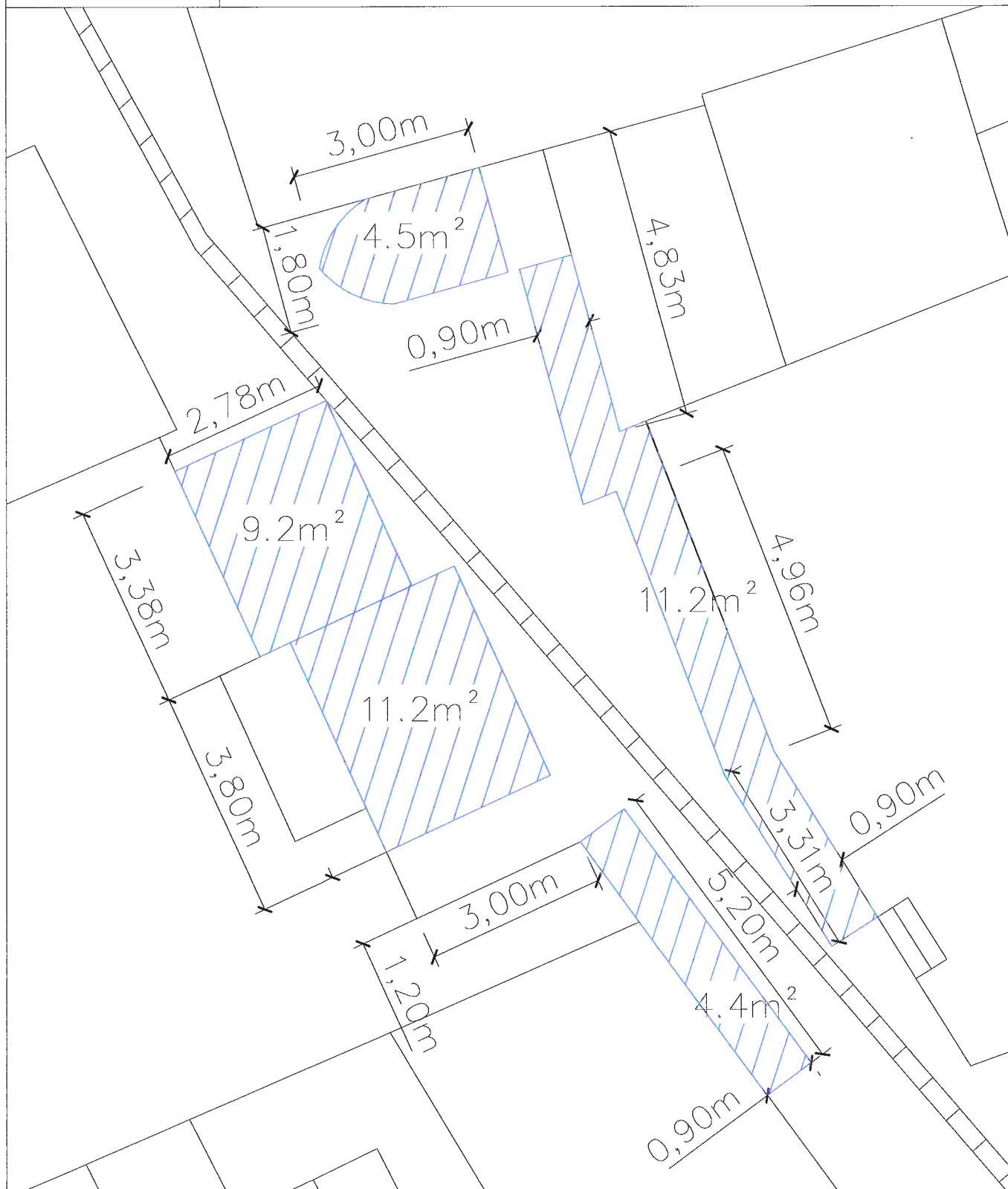

Terasa Broj 37.	Slastičarnica "Specijal" VI. Hetem Murati i Emin Murati Donja ulica
K.Č.BR.	2263/2
Zona	I.
Kvadratura	19,0m ²
Period	Sezonsko



Terasa Broj 38.	U.O. Zdravljak VI. Ersan Haljiti Srednja Ulica
K.Č.BR.	2263/51
Zona	I.
Kvadratura	0,7m ²
Period	Cjelogodišnje

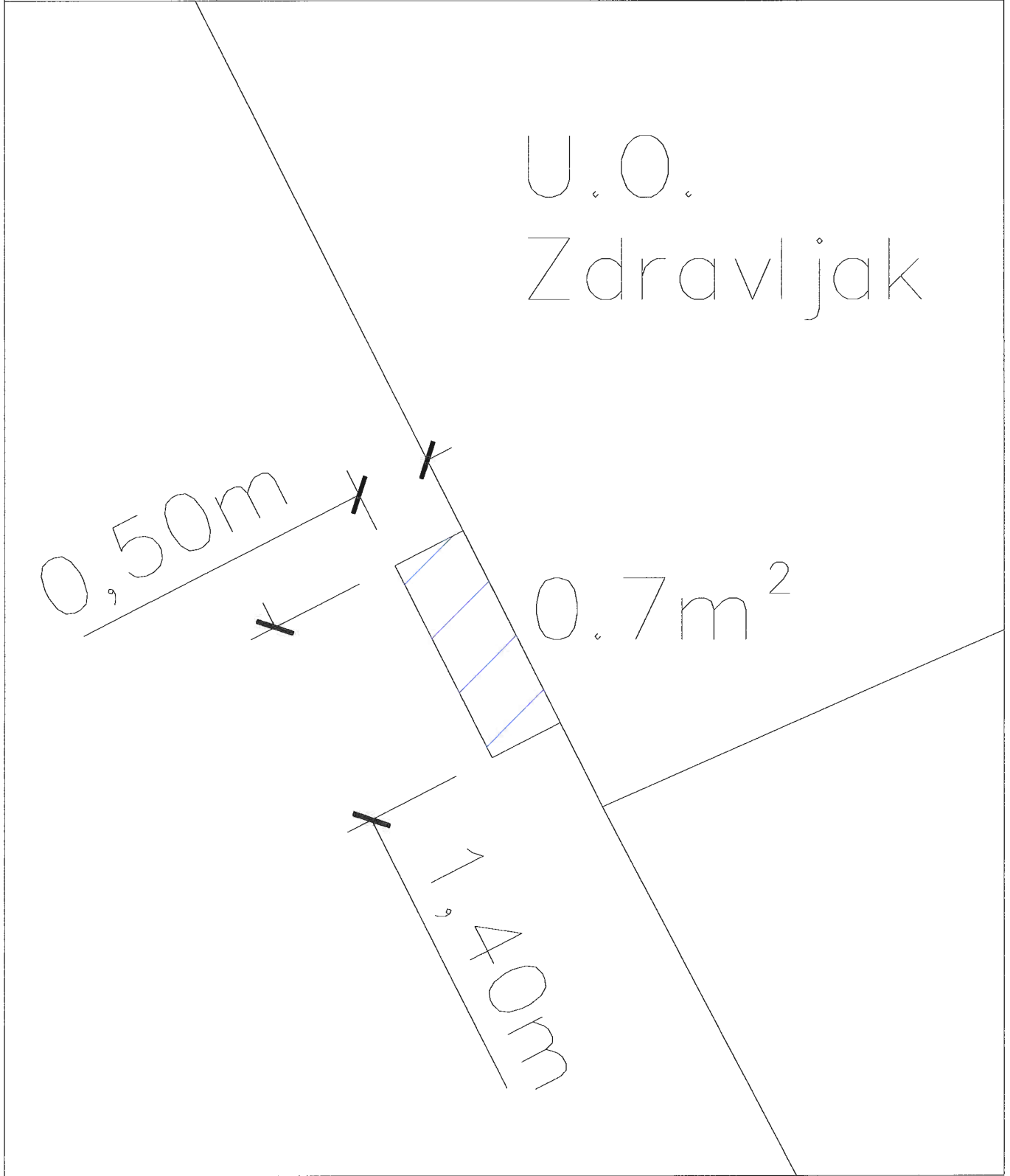

Terasa Broj 39.	Activet direct VI. Krešimir Šipek Donja ulica
K.Č.BR.	2263/2
Zona	I.
Kvadratura	12,0m ²
Period	Sezonsko

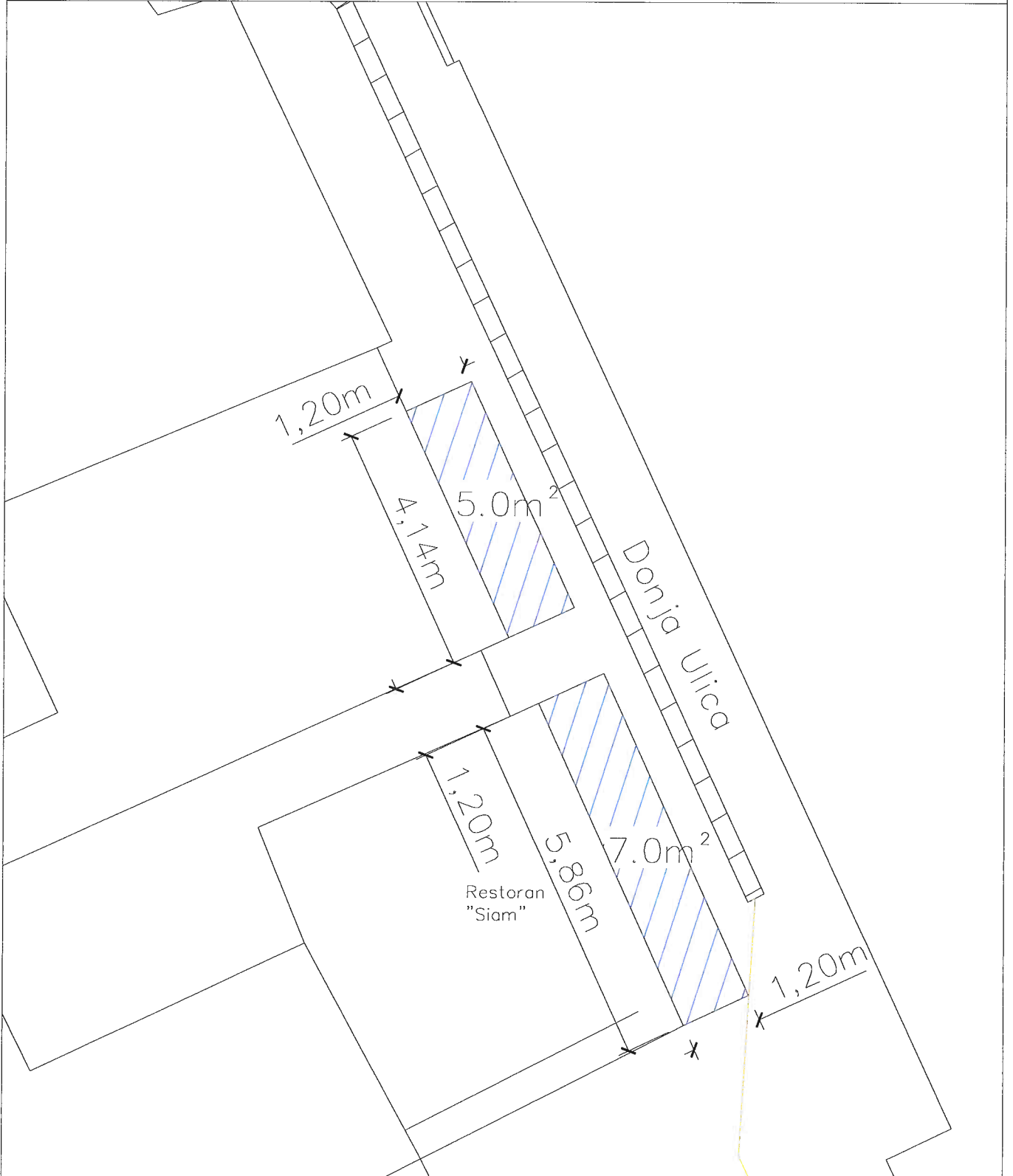

Terasa Broj 40.	Doner House j.d.o.o. VI Besart Džaferi Šetalište Markantuna de Dominisa
K.Č.BR.	140/12
Zona	I.
Kvadratura	35,0m ²
Period	Sezonsko

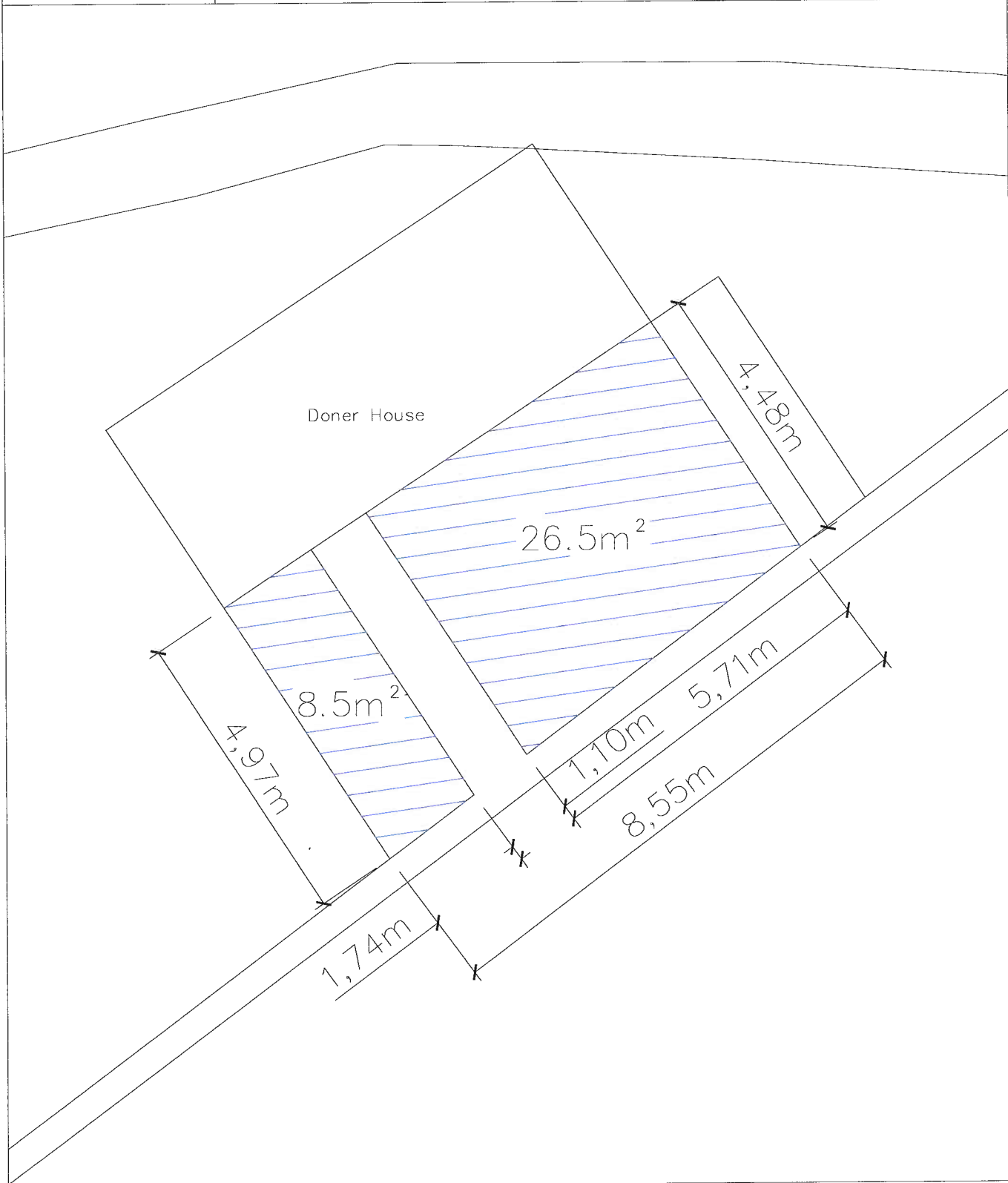

Terasa Broj 41.	Old spoon j.d.o.o. Vl. Jens Leisegang Donja Ulica
--------------------	--

K.Č.BR.	2263/2
---------	--------

Zona	I.
------	----

Kvadratura	12,0m ²
------------	--------------------

Period	Sezonsko
--------	----------

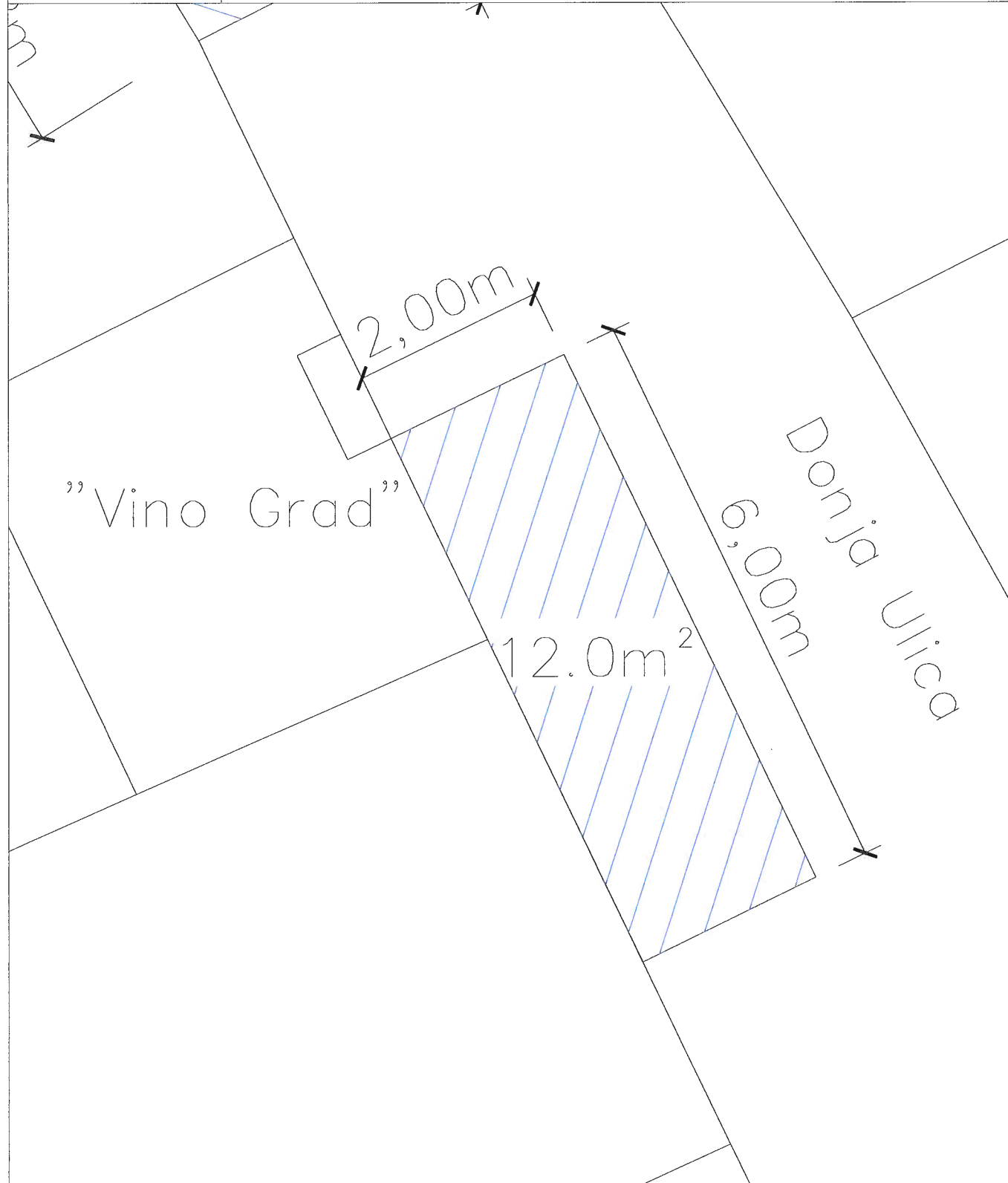

Terasa Broj 43.	U.O. Barea vl. Dražen Grozdanić "BLOK BAR Sportska dvorana Rab
K.Č.BR.	225/65
Zona	II.
Kvadratura	48,0m ²
Period	Sezonsko

